



MAGNAVOX

ALEXA CLOCK RADIO

VOICE ACTIVATED

OWNER'S MANUAL

PLEASE READ BEFORE OPERATING THIS EQUIPMENT.

MODEL: MSH318

Size: 148.5(W) x 210(H)mm (A5)



IMPORTANT SAFETY INSTRUCTIONS



CAUTION
RISK OF ELECTRIC SHOCK
DO NOT OPEN



CAUTION: TO REDUCE THE RISK OF ELECTRIC SHOCK, DO NOT REMOVE COVER (OR BACK). NO USER-SERVICEABLE PARTS INSIDE. REFER SERVICING TO QUALIFIED SERVICE PERSONNEL.



The lightning flash with arrowhead symbol within an equilateral triangle is intended to alert the user to the presence of uninsulated dangerous voltage within the product's enclosure that may be of sufficient magnitude to constitute a risk of electric shock to persons.



The exclamation point within an equilateral triangle is intended to alert the user to the presence of important operating and maintenance (servicing) instructions in the literature accompanying the appliance.

WARNING:
TO REDUCE THE RISK OF FIRE OR ELECTRIC SHOCK, DO NOT EXPOSE THIS PRODUCT TO RAIN OR MOISTURE.

WARNING:
TO REDUCE THE RISK OF FIRE OR ELECTRIC SHOCK, AND ANNOYING INTERFERENCE, USE THE RECOMMENDED ACCESSORIES ONLY.

FCC NOTICE:

This equipment has been tested and found to comply with the limits for a Class B digital device, pursuant to part 15 of the FCC Rules. These limits are designed to provide reasonable protection against harmful interference in a residential installation. This equipment generates, uses and can radiate radio frequency energy and, if not installed and used in accordance with the instructions, may cause harmful interference to radio communications.

However, there is no guarantee that interference will not occur in a particular installation. If this equipment does cause harmful interference to radio or television reception, which can be determined by turning the equipment off and on, the user is encouraged to try to correct the interference by one or more of the following measures:

- Reorient or relocate the receiving antenna.
- Increase the separation between the equipment and receiver.
- Connect the equipment into an outlet on a circuit different from that to which the receiver is connected.
- Consult the dealer or an experienced radio/TV technician for help.

FCC WARNING:

To assure continued compliance, follow the attached installation instructions and use only shielded cables when connecting to other devices. Modifications not authorized by the manufacturer may void user's authority to operate this device.

IMPORTANT SAFETY INSTRUCTIONS

Before using the unit, be sure to read all operating instructions carefully. Please note that these are general precautions and may not pertain to your unit. For example, this unit may not have the capability to be connected to an outdoor antenna.

1) Read these instructions.

All the safety and operating instructions should be read before the product is operated.

2) Keep these instructions.

The safety and operating instructions should be retained for future reference.

3) Heed all warnings.

All warnings on the product and in the operating instructions should be adhered to.

4) Follow all instructions.

All operating and use instructions should be followed.

5) Do not use this apparatus near water.

Do not use this product near water and moisture, for example: near a bathtub, washbowl, kitchen sink or laundry tub; in a wet basement; or near a swimming pool.

6) Clean only with dry cloth.

Unplug this product from the wall outlet before cleaning. Do not use liquid cleaners or aerosol cleaners. Use a dry cloth for cleaning.

7) Do not block any ventilation openings. Install in accordance with the manufacturer's instructions.

Slots and openings in the cabinet and in the back or bottom are provided for ventilation, to ensure reliable operation of the product and to protect it from overheating. These openings must not be blocked or covered. The openings should never be blocked by placing the product on a bed, sofa, rug or other similar surface. This product should never be placed near or over a radiator or heat source. This product should not be placed in a built-in installation such as a bookcase or rack unless proper ventilation is provided or the manufacturer's instructions have been adhered to.

8) Do not install near any heat sources such as radiators, heat registers, stoves, or other apparatus (including amplifiers) that produce heat.

9) Do not defeat the safety purpose of the polarized or grounding-type plug. A polarized plug has two blades with one wider than the other. A grounding type plug has two blades and a third grounding prong. The wide blade or the third prong are provided for your safety. If the provided plug does not fit into your outlet, consult an electrician for replacement of the obsolete outlet.

10) Protect the power cord from being walked on or pinched particularly at plugs, convenience receptacles, and the point where they exit from the apparatus.

11) Only use attachments/accessories specified by the manufacturer.

12) Use only with the cart, stand, tripod, bracket, or table specified by the manufacturer, or sold with the apparatus. When a cart is used, use caution when moving the cart/apparatus combination to avoid injury from tip-over.

An appliance and cart combination should be moved with care.

Quick stop, excessive force and uneven surfaces may cause the appliance and cart combination to overturn.



13) Unplug this apparatus during lightning storms or when unused for long periods of time.

To protect your product from a lightning storm, or when it is left unattended and unused for long periods of time, unplug it from the wall outlet and disconnect the antenna or cable system. This will prevent damage to the product due to lightning and power-line surges.

14) Refer all servicing to qualified service personnel. Servicing is required when the apparatus has been damaged in any way, such as power-supply cord or plug is damaged, liquid has been spilled or objects have fallen into the apparatus, the apparatus has been exposed to rain or moisture does not operate normally, or has been dropped.

15) Power source

This product should be operated only from the type of power source indicated on the marking label. If you are not sure of the type of power supply to your home, consult your appliance dealer or local power company. For products intended to operate from battery power, or other source, refer to the operation instructions.

16) Power lines

An outside antenna system should not be located in the vicinity of overhead power lines or other electric light or power circuits, or where it can fall into such power lines or circuits. When installing an outside antenna system, extreme care should be taken to keep from touching such power lines or circuits as contact with them might be fatal.

IMPORTANT SAFETY INSTRUCTIONS

17) Overloading

Do not overload wall outlets and extension cords as this can result in a risk of fire or electric shock.

18) Object and liquid entry

Never push objects of any kind into the product through openings as they may touch dangerous voltage points or short out parts that could result in fire or electric shock. Never spill or spray any type of liquid on the product.

19) Outdoor antenna grounding

If an outside antenna is connected to the product, be sure the antenna system is grounded so as to provide some protection against voltage surges and built up static charges. Section 810 of the National Electric Code ANSI/NFPA 70 provides information with respect to proper grounding of the mast and supporting structure, grounding of the lead-in wire to an antenna discharge product, size of grounding conductors, location of antenna-discharge product, connection to grounding electrodes and requirements for the grounding electrodes.

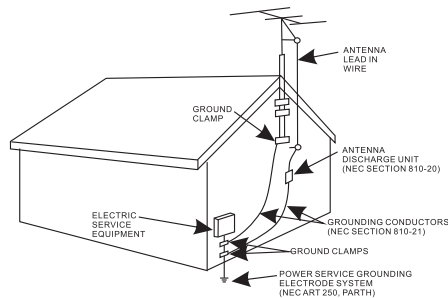

20) Service

Do not attempt to service this product yourself as opening or removing covers may expose you to dangerous voltage or other hazards. Refer all servicing to qualified service personnel.

21) Replacement parts

When replacement parts are required, be sure the service technician uses replacement parts specified by the manufacturer or those that have the same characteristics as the original parts. Unauthorized substitutions may result in fire or electric shock or other hazards.

22) Safety check

Upon completion of any service or repairs to this product, ask the service technician to perform safety checks to determine that the product is in proper operating condition.

23) Damage requiring service

Unplug this product from the wall outlet and refer service to qualified service personnel under the following conditions.

- When the power-supply cord or plug is damaged.
- If liquid has been spilled or objects have fallen into the product.
- If the product has been exposed to rain or water.
- If the product does not operate normally by following the operating instructions. Adjust only those controls that are covered by the operating instructions, as an adjustment of other controls may result in damage and will require extensive work by a qualified technician to restore the product to its normal operation.
- If the product has been dropped or the cabinet has been damaged.
- When the product exhibits a distinct change in performance—this indicates a need for service.

24) Note to CATV system installer

This reminder is provided to call the CATV system installer's attention to Article 820-40 of the NEC that provides guidelines for proper grounding and, in particular, specifies that the cable ground shall be connected to the grounding system of the building, as close to the point of cable entry as practical.

NOTE: Refer all servicing to qualified service personnel. Servicing is required when the unit has been damaged in any way such as the following: the power-supply cord or plug has been damaged, liquid has been spilled into unit, the unit has been exposed to rain or moisture, the unit has been dropped or the unit does not operate normally.

Location of Controls

TOP VIEW:

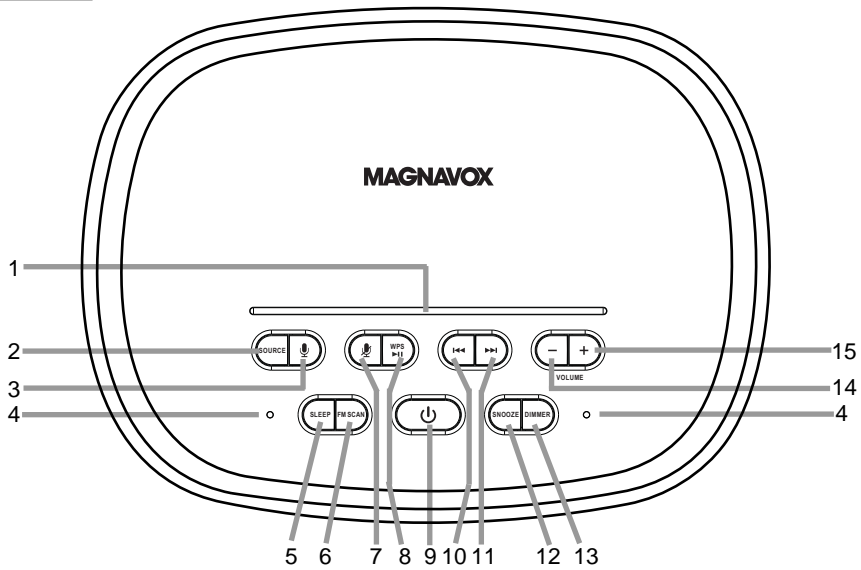

REAR VIEW:

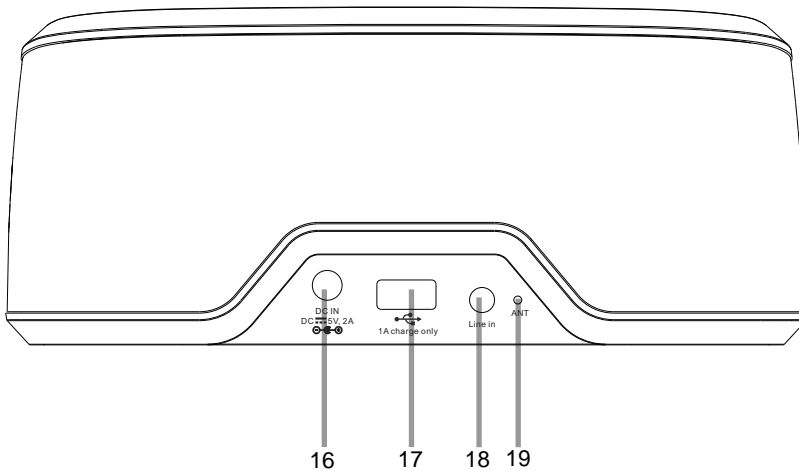

Location of Controls

FRONT VIEW:

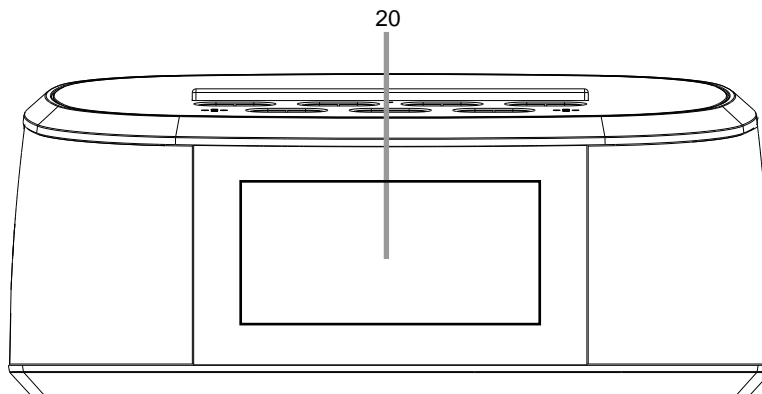

BOTTOM VIEW:

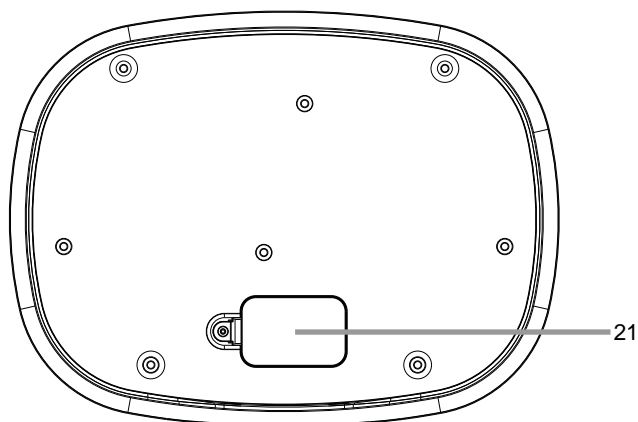

1. LED Indicator Bar

2. SOURCE Button

Press repeatedly to select the playback source

3.  Microphone Button

Press to active the Alexa Microphone

4. Built-in Microphones

Location of Controls

5. SLEEP Button

In power on mode, press repeatedly to activate and set the sleep timer.

6. FM SCAN Button

In first time use (or relocated the Clock to a new location), press to search and store the available FM stations.

7. Microphone Off Button

Press and hold to turn off the microphone; press and hold again to turn it on.

8. WPS (WPS, Play/Pause) Button

- In Wifi connecting mode, press and hold to enter to the Wifi set up mode.
- In Wifi connected mode, press and hold to disconnect Wifi network.
- In audio playback mode, press to pause. Press again to resume to normal playback.

9. (Power On/Off) Button

Press and hold to turn on the Clock from standby mode, press and hold again to back to standby mode.

10. (Previous) Button

- In Radio mode, press to play the previously stored Radio station.
- In music playback mode, press repeatedly to skip to previous tracks.

11. (Next) Button

- In Radio mode, press to play the next stored Radio station.
- In music playback mode, press repeatedly to skip to next tracks.

12. SNOOZE Button

When alarm goes off:

- Press to activate the snooze function, the alarm will turn back on automatically nine (9) minutes later. This feature can be repeatedly until the Alarm is shut off.
- Or, press and hold approximately 1 second to shut off the Alarm.

13. DIMMER Button

Press repeatedly to adjust the brightness level of the display as desired.

14. - (Volume Down) Button

Press repeatedly to reduce the volume level as desired.

15. + (Volume Up) Button

Press repeatedly to rise the volume level as desired.

16. DC IN Jack

17. USB Port

To recharging the external USB Device.

18. Line in Jack

19. ANT (FM Wire Antenna)

20. Display

21. Button Cell Compartment

Button Cell Installation (For Clock Back Up)

If there is AC power failure, this electronic clock is designed to continue operating internally (without showing the time on the Clock Display) with a CR2032 button cell (included). Install it (or replace it when it is drained) as follows:

1. Loosen the screw on the Button Cell Compartment with a Philips screwdriver (not included) as Fig. 1 below.
2. Press the tab on the door then lift it off.
3. Install (or replace) the button cell as Fig. 2 below according to the polarity diagram inside the Button Cell Compartment.
4. Close the door and tighten the screw on it as Fig. 3 shows below.

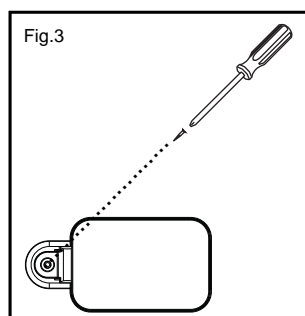
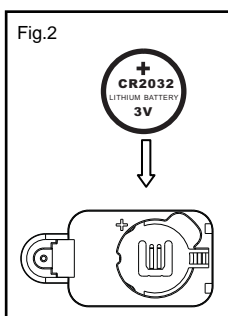
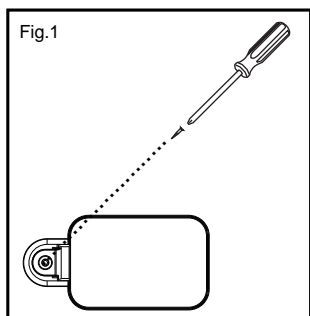

BATTERY PRECAUTIONS:

Follow these Battery Precaution when using a battery in this device:

1. Use only the size and type of battery specified.
2. Be sure to follow the correct polarity when installing the battery as indicated in the battery compartment. A reversed battery may cause damage to the device.
3. Do not mix different types of batteries together (e.g. Alkaline and Carbon-zinc) or old batteries with fresh ones.
4. If the batteries in the device are consumed or the device is not to be used for a long period of time, remove the batteries to prevent damage or injury from possible battery leakage.
5. Do not try to recharge the battery not intended to be recharged; it can overheat and rupture. (Follow battery manufacturer's instructions.)
6. Do not dispose of battery in fire. Battery may explodes or leak.
7. Clean the battery contacts and also those of the device prior to battery installation.
8.  This product contains a coin/button cell battery. If the coin/button cell battery is swallowed, it can cause severe internal burn in just 2 hours and can lead to death. Keep new and used batteries away from children. If the battery compartment does not close securely, stop using the product and keep it away from children. If you think batteries might have been swallowed or placed inside any part of the body, seek immediate medical attention.

WiFi Setup

To synchronize the correct time to your Clock you must connect your device to the same Wifi network with the “**Magnavox Alexa**” app following the instructions below.

Note: All Devices must connect to the same 2.4G Wi-Fi Network.

Preparation:

1. Create and register an Amazon user account:
(If you already have an Amazon account, you can skip this step. But, please make sure that you set in the same time zone your clock is located.)
 - Download the “**Amazon Alexa**” app from the Apps Store into your mobile device then install it following the on screen instructions from your mobile device.
 - During installation, you should register the time zone's region your clock will display. Otherwise, the actual time shown on the clock may be incorrect.

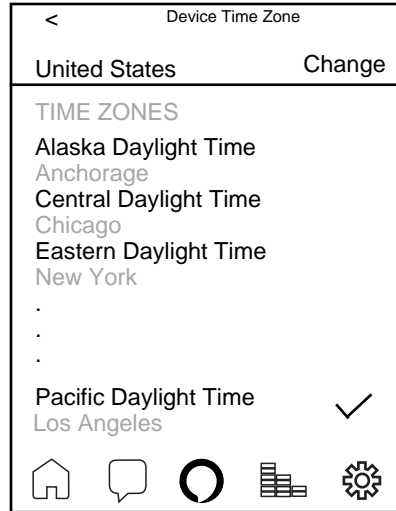
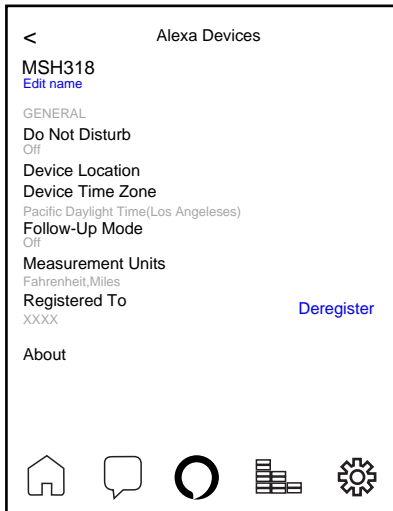

2. Download; install and register the “**MAGNAVOX Alexa Player**” app from the Google Play or Apple Apps Store into your mobile device following the on screen instructions from your mobile device.

Wifi Connection:

1. Make sure the time zone setting on your mobile device is same as your Amazon account. Otherwise, the time showing on the Clock may differ to your Amazon time.
2. Connect your mobile device to your 2.4G Wifi network.

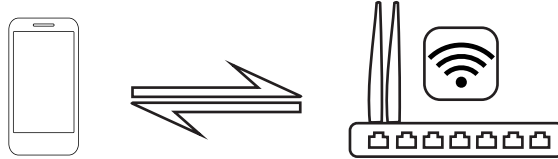

3. Connect the unit to AC power as below:

- Connect the small plug from the AC/DC adaptor to the **DC IN Jack** on the rear of the Clock.
- Connect the AC/DC adaptor to wall outlet having AC 100-240V~, 50/60Hz.

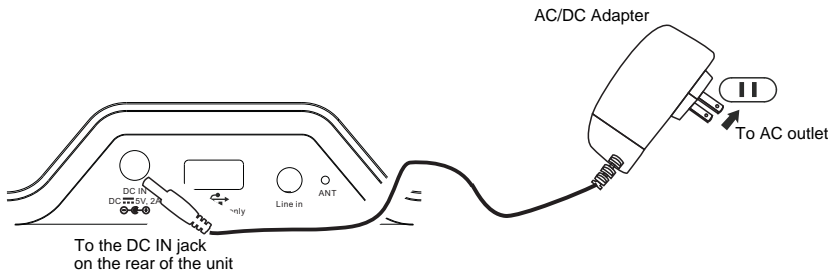

4. Press and hold the “⏻” Power Button until the display is illuminated . Time “12:00” will appear on the display and blink. You will also hear an audible prompt say “**Power on; Wi-Fi mode**”. The Wifi icon “📶” will appear on the display and blink.
5. Wait approximately 30 seconds (Or press and hold the“**WPS ►**” Button) until you hear an audible prompt say “**Entering set up mode; follow the instruction on the app to finish set up**”.

6. Open the APP “**MAGNAVOX Alexa Player**” in your mobile device. Then it will start to scan and search the available devices automatically. Read the on screen instructions and touch the “**Add Device**” Button on the screen to continue.

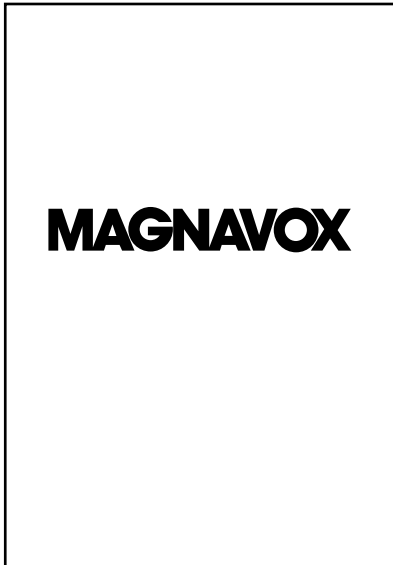

7. The following Fig.A will appear. Touch the “**V**” Button on the screen. The devices list will appear. Touch the “**MSH318**” on it. The follows Fig. B will appear. Touch the “**Connect Speaker**” Button on the screen to continue.



Fig. A

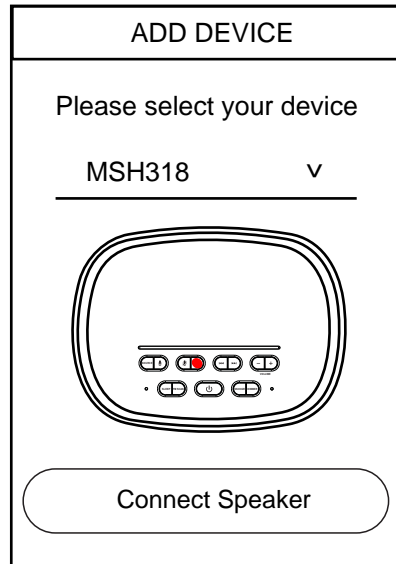
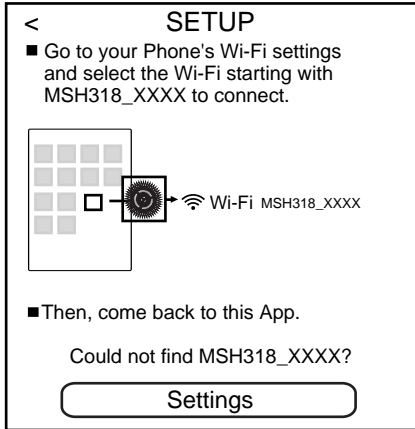
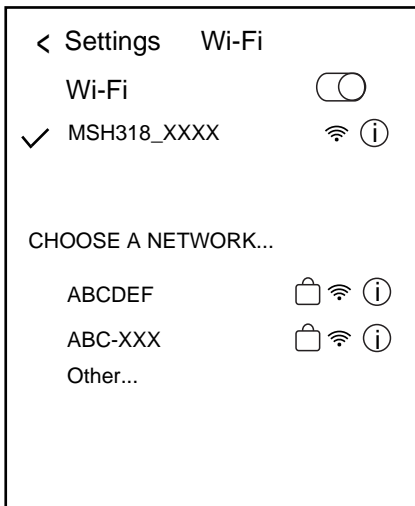

Fig. B

8. The follows screen will appear. Touch the **“Settings”** Button on it to enter to Wifi setting menu.



9. Find our Model number **“MSH318_XXX”** (XXX is the identify number of the existing Clock) in the available Wifi devices list on your mobile device then touch it to enter.



NOTE:

If the connection is failure and the follows screen appear. Press and hold the **“WPS ►”** Button approximately 5 seconds to restart the setting procedures.

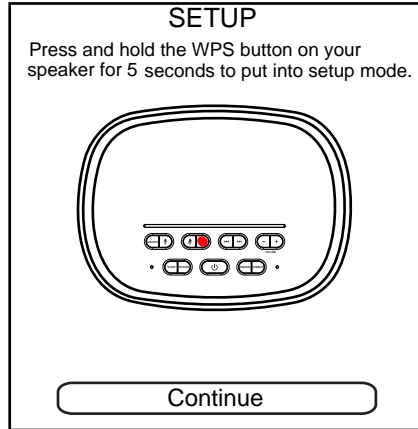

10. Touch the **“RETURN”** Button on the mobile device's screen to return to previous setting page. Wait a few seconds, the Wifi network list will appear. Select and touch the button of your 2.4G Wifi network. Then touch the **“Continue”** Button to continue.

Notes: • The Wifi network you selected must same as the 2.4G network your mobile device using.
• Password of the network may need enter if set.

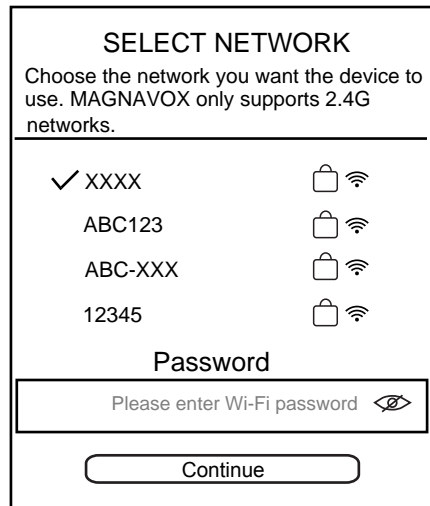

11. Wait a few seconds, the follows screen will appear. Touch the "Next" Button on it to continue.

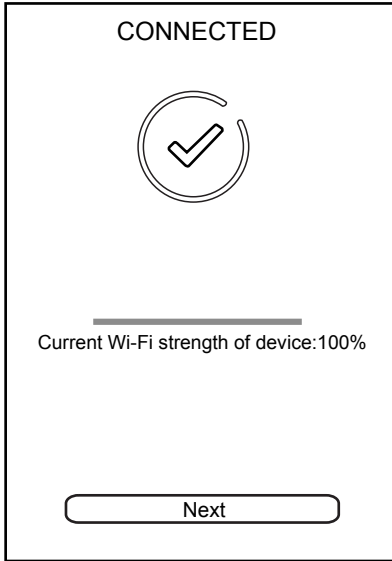

12. The follows screen will appear, touch the ">" Button on it to continue.

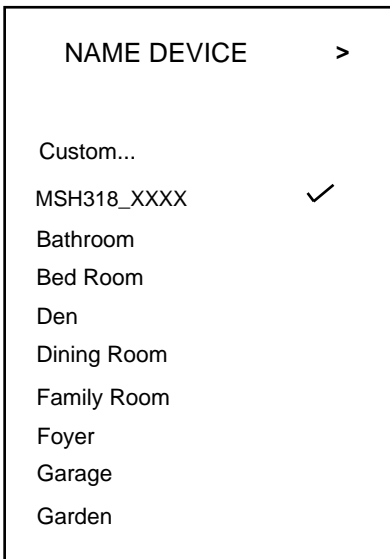

NOTE:

If the connection is failure, the following screen will appear. Touch the "**Try Again**" Button on it to restart the settings follows the on screen instructions.

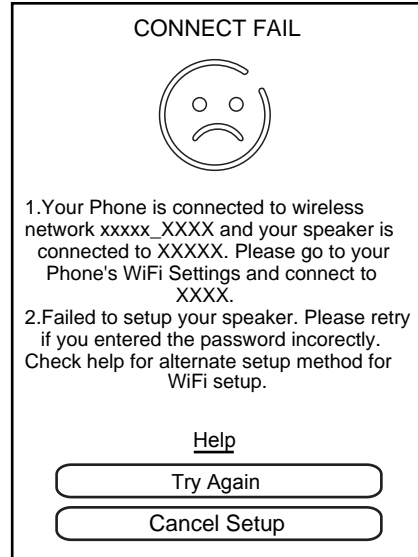

13. The follows screen will appear, touch the "**Sign in with Amazon**" Button on it to continue.

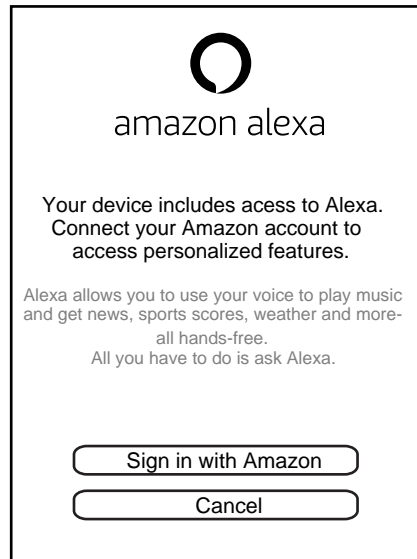

14. The follows screen will appear, sign in your Amazon account follows the on screen instructions.

15. If you do not have an Amazon account, then touch **“Create a new Amazon account”** Button to start registration and create a new Amazon account follows the on screen instructions.

16. When sign in, the following screen appear, touch the **“Allow”** Button on it to continue.

17. The following screen will appear, select and set the region you are, then touch **“Next”** Button to continue.

18. The following screen will appear, touch the button of the desired language.
19. The following screen will appear, touch the “Next” Button on it.

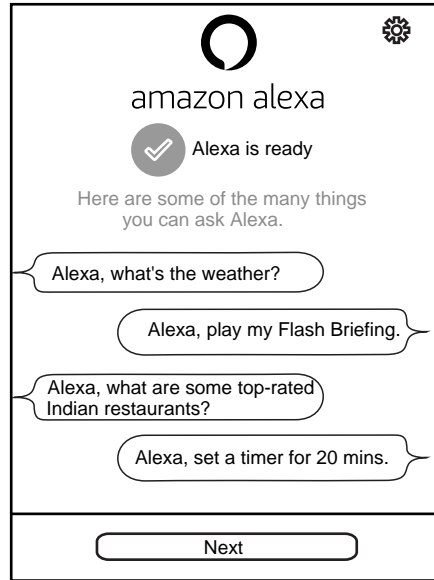

20. The following screen will appear. Then you can turn off the Alexa Microphone following the on screen instructions or touch the “Next” Button to skip this setting then go to next step.
21. The following screen will appear, touch the “I got it” Button to complete the settings.

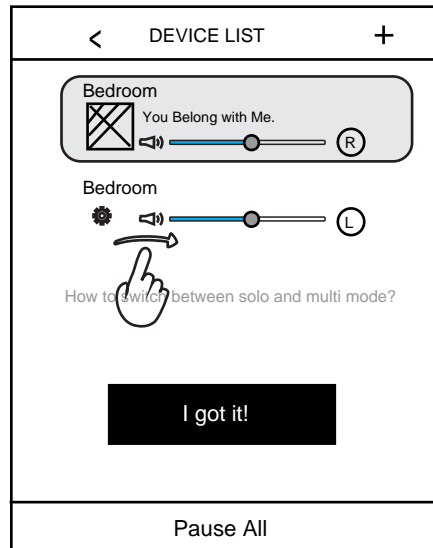

22. Once the set up is finished, press and hold the “⏻” Power Button to turn the Clock to standby mode. You will hear an audible prompt say “Power off”.

Operation

Alexa:

1. After the Clock was connected to Wifi network and sign in to Amazon as instructed earlier. Press and hold the “⏻” Power Button approximately 1 second to turn on the clock from standby mode. Icon “📶” will appear on the display and you will hear an audible prompt say “**Power on; Wi-Fi mode**”.
2. Wait approximately 30 seconds until the clock is automatically connected to your Wi-fi network and Amazon, you will hear an audible prompt say “**Connected to your Wifi network**”.
3. Say “**Alexa**” to the microphone or press the “🎤” Microphone Button, the Indicator Bar will illuminate. Ask your questions or instructions to the microphone then wait for a reply from Alexa. For example, You can ask:
 - (Alexa) Who are you?
 - (Alexa) What's the time now?
 - (Alexa) What's the news today?
 - (Alexa) Play a song.
 - (Alexa) Stop (or Pause) the song.
4. When finished, press and hold the “⏻” Power Button to turn the unit to standby mode. You will hear an audible prompt say “**Power off**”.

ALARM:

Alarm set:

1. In Wifi connection mode, say “**Alexa**” to the microphone or press the “🎤” Microphone Button, the Indicator Bar will illuminate. Then, ask Alexa to:
 - (Alexa) Set an alarm.
Alexa will reply: Alarm for what time?
 - (Alexa) Eight AM.
Alexa will reply: Alarm set for eight AM.
2. When alarm is set and activated, the indicator “alarm1” will appear on the display.

3. More than one alarm can be set, repeated the same procedures until all alarms are set.

IMPORTANT:

When using the Alexa alarm clock (or timer), make sure the Clock is in power on mode and connected to the Wifi network and Amazon continually. Otherwise, the alarm will not function.

Snooze:

When alarm goes off, press the SNOOZE Button, the Indicator Bar will illuminate and blink. The alarm will turn back on automatically nine (9) minutes later. This feature can be repeatedly until the Alarm is turned off.

Shut off alarm:

When alarm goes off, press and hold the SNOOZE Button to shut off alarm. The indicator "alarm1" will disappear on the display.

Cancel alarm:

In Wifi connection mode, say "**Alexa**" to the microphone or press the "🎤" Microphone Button, the Indicator Bar will illuminate. Then, ask Alexa to:

- (Alexa) Cancel alarm.
- Alexa will reply: XX alarm cancel.
- If more than one alarm time was set, cancel it following her instructions.

RADIO:

1. Press and hold the "⏻" Power Button approximately 1 second to turn on the clock from standby mode. Indicator "📶" will appear on the display and you will hear an audible prompt say "**Power on; Wi-Fi mode**".
2. Press the "**Source**" Button repeatedly until the indicator "**radio**" appears on the display.
3. In first time use (or relocated the Clock to a new location), search and store the available FM stations by pressing the "**FM SCAN**" Button. The Clock will automatically search and store all available FM radio stations then play the first stored FM station.

4. Press the ◀◀ or ▶▶ (Back or Forward) buttons repeatedly to select and play the desired stored radio station.
5. Press the **VOLUME +/-** buttons to adjust volume level as desired.
6. When finished, press and hold the “⏻” Power Button to turn the unit to standby mode. You will hear an audible prompt say “**Power off**”.

Antennas:

The FM Wire Antenna on the rear of unit is for FM reception. If reception is weak, unwind it to full length and/or reassemble the other direction/location to improve reception.

AUX/LINE IN:

Listen music from the external Audio Player such as MP3 Player, Discman... ETC:

1. In power off mode, connect one end of the Audio Connection Cable (not included) to the AUX Out / Line Out / Phone Jack on the external Audio Player.
2. Connect the other end of the cable to the “**Line in**” Jack on the rear of the Clock.
3. In power on mode, press the “**Source**” Button repeatedly until the indicator “**line-in**” appear on the display. You will also hear an audible prompt say “**Auxiliary Mode**”.
4. Play the music on the connected Player as usual. (Make sure the volume level of the connected Audio Player is turned to high level.)
5. Press the **VOLUME +/-** buttons to adjust volume level as desired.
6. When finished, press and hold the “⏻” Power Button to turn the unit to standby mode. You will hear an audible prompt say “**Power off**”.



MUSIC PLAYBACK:

Stream and play music through the Clock from Amazon:

1. Press and hold the “⏻” Power Button approximately 1 second to turn on the clock from standby mode. Icon “📶” will appear on the display and you will hear an audible prompt say “**Power on; Wi-Fi mode**”.
2. Wait approximately 30 seconds until the clock is automatically connected to your Wi-fi network and Amazon, you will hear an audible prompt say “**Connected to your Wifi network**”.

3. Say “**Alexa**” to the microphone or press the “” Microphone Button, the Indicator Bar will illuminate. Say your instructions to the microphone then wait the reply from her.
4. You can say:
(Alexa) Play the song.
5. Then select and play the music following Alexa instructions.

You can also stream and play music through the Clock from your mobile device on your Wifi network by using the “MAGNAVOX Alexa Player” app.

1. Press and hold the “” Power Button approximately 1 second to turn on the clock from standby mode. Icon “” will appear on the display and you will hear an audible say “**Power on; Wi-Fi mode**”.
2. Wait approximately 30 seconds until the clock is automatically connected to your Wi-fi network and Amazon, you will hear an audible prompt say “**Connected to your Wifi network**”.
3. Open the “**MAGNAVOX Alexa Player**” app in your mobile device. Play the music on your device or through other Music Store following the on screen instructions.

BUILT-IN USB CHARGER:

The Clock has a built-in USB Charger, connect the external USB Device to the **USB Port** on the rear of the Clock for recharging.

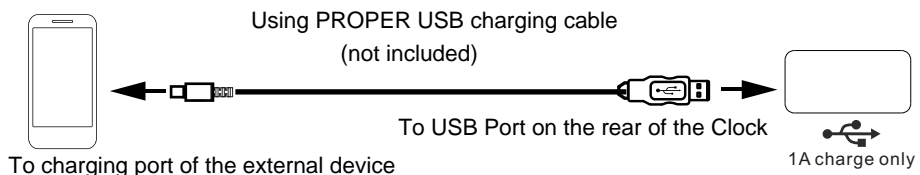

DIMMER:

Press the “**DIMMER**” Button repeatedly to adjust the brightness level of the display as desired.

SLEEP TIMER:

Press the “**SLEEP**” Button to activate the sleep function, sleep timer will appear on the display. Press the button repeatedly to set the sleep timer to 10 – 90 minutes as desired. To turn off the sleep timer before the time is up, press and hold the “” Power Button to turn the Clock to standby mode.

Cleaning

1. To prevent fire or shock hazard, disconnect your unit from the AC wall outlet when cleaning.
2. The finish on your unit may be cleaned with a dust cloth and cared for as other furniture. Use caution when cleaning and wiping the plastic parts.
3. Mild soap and a damp cloth may be used.

Troubleshooting Guide



Check the following before requesting service:

SYMPTOM	POSSIBLE CAUSE	POSSIBLE SOLUTION
Can't power on	The adapter is not plugged	Plug the adapter properly
No sound or sound weak	Volume level in minimum position	Raise the volume level by pressing the + Button on the top of Clock
	Volume level of paired/connected device is in low level	Raise the volume level of the connected device
Sound distortion	Volume level too high	Reduce the volume level by pressing the - Button on the top of Clock
	Volume level of the connected device too high	Reduce the volume level of the connected device
Wi-Fi not functioning	The Clock had NOT add in the Wi-Fi network and had NOT sign in Amazon account	Add the Clock into the Wi-Fi network and sign in Amazon account as page 9-15
	The Clock is in standby mode	Press and hold the "⏻" Button to turn on the Clock from standby mode
	The Clock and the mobile devices is not in the same 2.4G Wi-Fi network	Set the Clock and the mobile device in the same 2.4G Wi-Fi network
FM weak reception		Unwind the FM Wire Antenna to its full length and/or reassemble the other direction/location to improve reception
Amazon Alexa not functioning	The unit is not in the Amazon Alexa operation mode	Power on the unit and enter to Amazon Alexa operate mode as page 16

General Specifications

Power Source:	DC  5V, 2A, 
Wifi Type:	IEEE 802.11 b/g/n
Wi-Fi Operation Range:	up to 96 feet in open area
FM Radio Coverage:	87.5-108.0 MHz
Clock Back Up:	1 x CR2032 Button Cell
USB Charger Output:	DC  5V, 1A Max. 

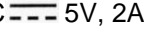
Accessories

- 1 x Owner's Manual
- 1 x AC/DC Adaptor (Input: AC 100-240V~, 50/60 Hz, 0.5A Max
Output: DC  5V, 2A, 

**SPECIFICATIONS AND ACCESSORIES ARE SUBJECT TO CHANGE
WITHOUT NOTICE**

LIMITED WARRANTY

Craig Electronics warrants this product to be free from manufacturing defects in material and workmanship under normal use for a period of 180 days from date of purchase. If service is required, please return the product to the store where it was purchased for exchange; or, pack the unit in the original packing material with all accessories if applicable, a copy of your sales receipt and a Cashier's check or Money Order for \$15 (to cover shipping and handling costs) payable to Craig Electronics Inc. For consumers in Canada, please make sure that the cashier check or money order is redeemable through a U.S. bank. Ship your product freight pre-paid. Your unit will be repaired, replaced or if the unit cannot be repaired or replaced, a refund will be forwarded to you within four weeks of receipt of your unit. Please ship your unit to:

Craig Electronics Inc.
1160 NW 163 Drive
Miami, FL 33269

This warranty is void if the product has been: a) Used in a commercial application or rental. b) Damaged through misuse, negligence, or abuse. c) Modified or repaired by anyone other than an authorized Craig service center. d) Damaged because it is improperly connected to any other equipment.

Note: This warranty does not cover: a) Ordinary adjustments as outlined in the Owner's Manual which can be performed by the customer. b) Damage to equipment not properly connected to the product. c) Any cost incurred in shipping the product for repair. d) Damage to the product not used in the USA.

This warranty is not transferable and only applies to the original purchase. Any implied warranties, including the warranty of merchantability, are limited in duration to the period of this expressed warranty and no warranty whether expressed or implied shall apply to the product thereafter.

Under no circumstance shall Craig be liable for any loss or consequential damage arising out of the use of this product. This warranty gives specific legal rights. However, you may have other rights which may vary from state to state. Some states do not allow limitations on implied warranties or exclusion of consequential damage. Therefore, these restrictions may not apply to you.

This product has been manufactured by and is sold under the responsibility of Craig Electronics Inc, and Craig Electronics Inc is the warrantor in relation to this product. MAGNAVOX and SMART. VERY SMART are registered trademarks of Koninklijke Philips N.V. and are used under license from Koninklijke Philips N.V.

To Obtain Service on your Product
email: magnavox@craigelectronics.com