



**MAGNAVOX**

# **WATERPROOF PORTABLE SPEAKER SYSTEM**

**with Decorative Color Changing Lights  
and Bluetooth® Wireless Technology**

***OWNER'S MANUAL***

PLEASE READ BEFORE OPERATING THIS EQUIPMENT.

**MODEL: MHT833**

Size: 148.5(W) x 210(H)mm (A5)

# IMPORTANT SAFETY INSTRUCTIONS

	<b>CAUTION</b> <b>RISK OF ELECTRIC SHOCK</b> <b>DO NOT OPEN</b>	
<p>CAUTION: TO REDUCE THE RISK OF ELECTRIC SHOCK, DO NOT REMOVE COVER (OR BACK). NO USER-SERVICEABLE PARTS INSIDE. REFER SERVICING TO QUALIFIED SERVICE PERSONNEL.</p>		

**CAUTION:**  
THIS DIGITAL VIDEO DISC PLAYER EMPLOYS A LASER SYSTEM.  
TO ENSURE PROPER USE OF THIS PRODUCT, PLEASE READ THIS OWNER'S MANUAL CAREFULLY AND RETAIN FOR FUTURE REFERENCE. SHOULD THE UNIT REQUIRE MAINTENANCE, CONTACT AN AUTHORIZED SERVICE LOCATION-SEE SERVICE PROCEDURE.  
USE CONTROLS, ADJUSTMENTS OR THE PERFORMANCE OF PROCEDURES OTHER THAN THOSE SPECIFIED HEREIN MAY RESULT IN HAZARDOUS RADIATION EXPOSURE.  
TO PREVENT DIRECT EXPOSURE TO LASER BEAM, DO NOT TRY TO OPEN THE ENCLOSURE. VISIBLE LASER RADIATION MAY BE PRESENT WHEN THE ENCLOSURE IS OPENED. DO NOT STARE INTO BEAM.

**WARNING:**  
TO REDUCE THE RISK OF FIRE OR ELECTRIC SHOCK, AND ANNOYING INTERFERENCE, USE THE RECOMMENDED ACCESSORIES ONLY.



The lightning flash with arrowhead symbol within an equilateral triangle is intended to alert the user to the presence of uninsulated dangerous voltage within the product's enclosure that may be of sufficient magnitude to constitute a risk of electric shock to persons.



The exclamation point within an equilateral triangle is intended to alert the user to the presence of important operating and maintenance (servicing) instructions in the literature accompanying the appliance.

**FCC NOTICE:**  
This equipment has been tested and found to comply with the limits for a Class B digital device, pursuant to part 15 of the FCC Rules. These limits are designed to provide reasonable protection against harmful interference in a residential installation. This equipment generates, uses and can radiate radio frequency energy and, if not installed and used in accordance with the instructions, may cause harmful interference to radio communications.  
However, there is no guarantee that interference will not occur in a particular installation. If this equipment does cause harmful interference to radio or television reception, which can be determined by turning the equipment off and on, the user is encouraged to try to correct the interference by one or more of the following measures:

- Reorient or relocate the receiving antenna.
- Increase the separation between the equipment and receiver.
- Connect the equipment into an outlet on a circuit different from that to which the receiver is connected.
- Consult the dealer or an experienced radio/TV technician for help.

**FCC WARNING:**  
To assure continued compliance, follow the attached installation instructions and use only shielded cables when connecting to other devices. Modifications not authorized by the manufacturer may void user's authority to operate this device.

# IMPORTANT SAFETY INSTRUCTIONS

Before using the unit, be sure to read all operating instructions carefully. Please note that these are general precautions and may not pertain to your unit.

For example, this unit may not have the capability to be connected to an outdoor antenna.

1) **Read these instructions.**

All the safety and operating instructions should be read before the product is operated.

2) **Keep these instructions.**

The safety and operating instructions should be retained for future reference.

3) **Heed all warnings.**

All warnings on the product and in the operating instructions should be adhered to.

4) **Follow all instructions.**

All operating and use instructions should be followed.

5) **Do not use this apparatus near water.**

Do not use this product near water and moisture, for example: near a bathtub, washbowl, kitchen sink or laundry tub; in a wet basement; or near a swimming pool.

6) **Clean only with dry cloth.**

Unplug this product from the wall outlet before cleaning. Do not use liquid cleaners or aerosol cleaners. Use a dry cloth for cleaning.

7) **Do not block any ventilation openings. Install in accordance with the manufacturer's instructions.**

Slots and openings in the cabinet and in the back or bottom are provided for ventilation, to ensure reliable operation of the product and to protect it from overheating. These openings must not be blocked or covered. The openings should never be blocked by placing the product on a bed, sofa, rug or other similar surface. This product should never be placed near or over a radiator or heat source. This product should not be placed in a built-in installation such as a bookcase or rack unless proper ventilation is provided or the manufacturer's instructions have been adhered to.

8) **Do not install near any heat sources such as radiators, heat registers, stoves, or other apparatus (including amplifiers) that produce heat.**

9) **Do not defeat the safety purpose of the polarized or grounding-type plug. A polarized plug has two blades with one wider than the other. A grounding type plug has two blades and a third grounding prong. The wide blade or the third prong are provided for your safety. If the provided plug does not fit into your outlet, consult an electrician for replacement of the obsolete outlet.**

10) **Protect the power cord from being walked on or pinched particularly at plugs, convenience receptacles, and the point where they exit from the apparatus.**

11) **Only use attachments/accessories specified by the manufacturer.**

12) **Use only with the cart, stand, tripod, bracket, or table specified by the manufacturer, or sold with the apparatus. When a cart is used, use caution when moving the cart/apparatus combination to avoid injury from tip-over.**

An appliance and cart combination should be moved with care.

Quick stop, excessive force and uneven surfaces may cause the appliance and cart combination to overturn.



Portable Cart Warning

13) **Unplug this apparatus during lightning storms or when unused for long periods of time.**

To protect your product from a lightning storm, or when it is left unattended and unused for long periods of time, unplug it from the wall outlet and disconnect the antenna or cable system. This will prevent damage to the product due to lightning and power-line surges.

14) **Refer all servicing to qualified service personnel. Servicing is required when the apparatus has been damaged in any way, such as power-supply cord or plug is damaged, liquid has been spilled or objects have fallen into the apparatus, the apparatus has been exposed to rain or moisture does not operate normally, or has been dropped.**

15) **Power source**

This product should be operated only from the type of power source indicated on the marking label.

If you are not sure of the type of power supply to your home, consult your appliance dealer or local power company. For products intended to operate from battery power, or other source, refer to the operation instructions.

16) **Power lines**

An outside antenna system should not be located in the vicinity of overhead power lines or other electric light or power circuits, or where it can fall into such power lines or circuits. When installing an outside antenna system, extreme care should be taken to keep from touching such power lines or circuits as contact with them might be fatal.

# IMPORTANT SAFETY INSTRUCTIONS

## 17) Overloading

Do not overload wall outlets and extension cords as this can result in a risk of fire or electric shock.

## 18) Object and liquid entry

Never push objects of any kind into the product through openings as they may touch dangerous voltage points or short out parts that could result in fire or electric shock. Never spill or spray any type of liquid on the product.

## 19) Outdoor antenna grounding

If an outside antenna is connected to the product, be sure the antenna system is grounded so as to provide some protection against voltage surges and built up static charges. Section 810 of the National Electric Code ANSI/NFPA 70 provides information with respect to proper grounding of the mast and supporting structure, grounding of the lead-in wire to an antenna discharge product, size of grounding conductors, location of antenna-discharge product, connection to grounding electrodes and requirements for the grounding electrodes.

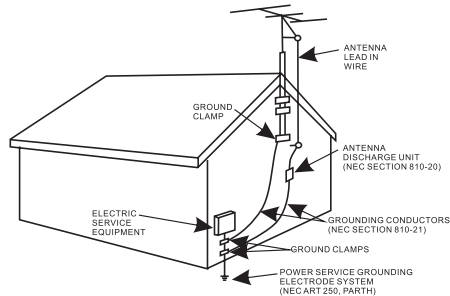

## 20) Service

Do not attempt to service this product yourself as opening or removing covers may expose you to dangerous voltage or other hazards. Refer all servicing to qualified service personnel.

## 21) Replacement parts

When replacement parts are required, be sure the service technician uses replacement parts specified by the manufacturer or those that have the same characteristics as the original parts. Unauthorized substitutions may result in fire or electric shock or other hazards.

## 22) Safety check

Upon completion of any service or repairs to this product, ask the service technician to perform safety checks to determine that the product is in proper operational condition.

## 23) Wall or ceiling mounting

The product should be mounted to a wall or ceiling only as recommended by the manufacturer.

## 24) Damage requiring service

Unplug this product from the wall outlet and refer service to qualified service personnel under the following conditions.

- When the power-supply cord or plug is damaged.
- If liquid has been spilled or objects have fallen into the product.
- If the product has been exposed to rain or water.
- If the product does not operate normally by following the operating instructions. Adjust only those controls that are covered by the operating instructions, as an adjustment of other controls may result in damage and will require extensive work by a qualified technician to restore in the product to its normal operation.
- If the product has been dropped or the cabinet has been damaged.
- When the product exhibits a distinct change in performance—this indicates a need for service.

## 25) Note to CATV system installer

This reminder is provided to call the CATV system installer's attention to Article 820-40 of the NEC that provides guidelines for proper grounding and, in particular, specifies that the cable ground shall be connected to the grounding system of the building, as close to the point of cable entry as practical.

**NOTE: Refer all servicing to qualified service personnel. Servicing is required when the unit has been damaged in any way such as the following: the power-supply cord or plug has been damaged, liquid has been spilled into unit, the unit has been exposed to rain or moisture, the unit has been dropped or the unit does not operate normally.**

# LOCATION OF CONTROLS

## TOP PANEL

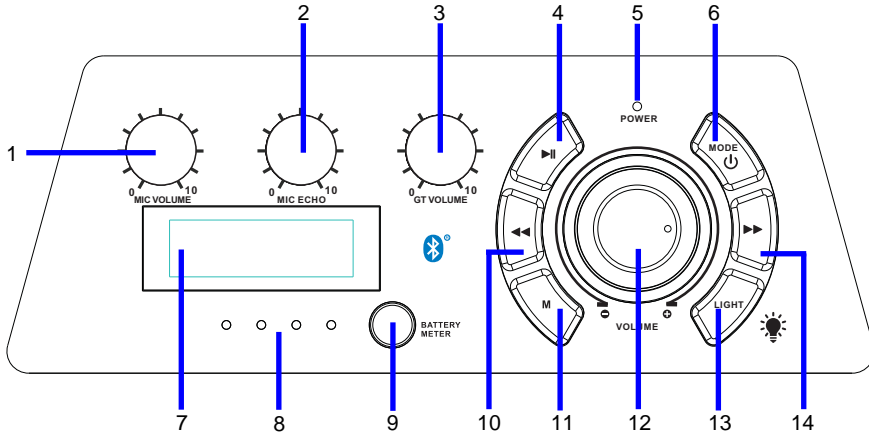

## FRONT VIEW

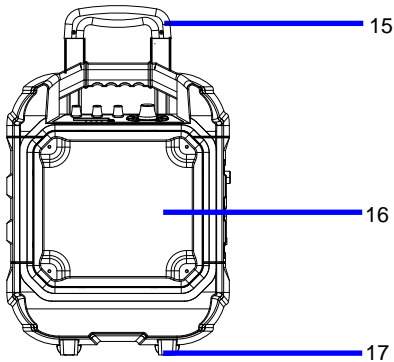

## SIDE PANEL

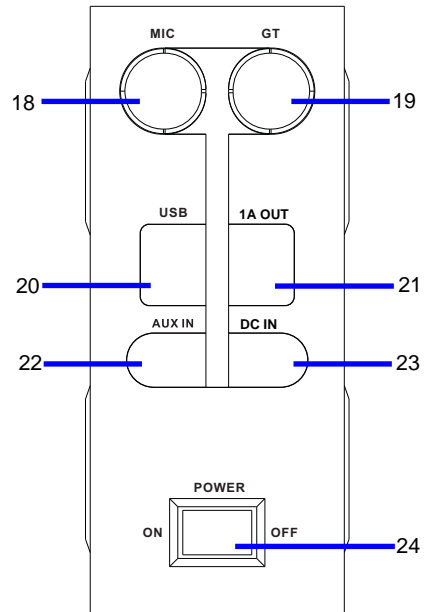

1. MIC VOLUME (Microphone Volume) Control Knob
2. MIC ECHO (Microphone Echo) Control Knob
3. GT VOLUME (Guitar Volume) Control Knob
4. ►|| (Play/Pause) Button
5. POWER Indicator
6. MODE/⏻ (Mode selection/Power) Button
7. LED Display
8. Indicators of Battery Meter
9. BATTERY METER Button
10. ◀◀ Button
11. M (Memory) Button
12. VOLUME Control Knob
13. LIGHT Button
14. ▶▶ Button
15. Retractable Handle
16. Decorative LED Lights

17. Wheels
18. MIC (Microphone Input) Jack
19. GT (Guitar Input) Jack
20. USB Port
21. 1A OUT (USB charging) Jack
22. AUX IN Jack
23. DC IN Jack ( DC  $\equiv$  15V, 2A,  $\ominus$   $\oplus$  )
24. POWER ON-OFF Switch

# POWER SOURCE

The unit has a built-in Sealed Lead Acid rechargeable battery, recharge it before use or when it is drained as follows:

1. Connect the small plug from the supplied AC/DC Adaptor to the DC IN Jack on the right of unit as the illustrated below.
2. Plug the AC/DC Adaptor to the AC wall outlet having AC 100-240V~, 50/60Hz as illustrated below.
3. During charging, the Indicators on the Battery Meter will illuminate and blink to show the charging status. When finished charging, all indicators on it will illuminate and stop blinking.
4. During charging, you can also play and listen to music at the same time.

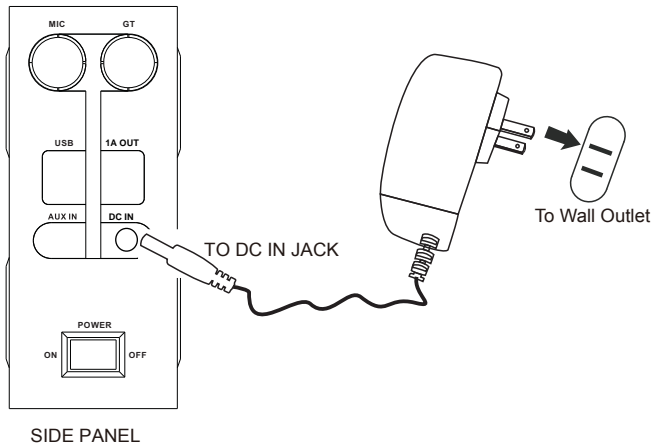

## Notes:

Your battery will last longer if you're following these simple guidelines for caring and storing.

- A. Before first time use, charge it approximately 10 hours until the unit is fully charged.
- B. Recharge and store the unit within the temperature range of 5°C~35°C (40°F~95°F).
- C. Do not charge longer than 24 hours. Excessive charging or running the unit until the battery fully drains will damage battery. Battery life will be extended if you keep the battery fully charged.
- D. Battery life naturally shortens slowly over time.
- E. The rechargeable battery incorporated in this product is not user replaceable.
- F. If long period of time not in use, unplug the AC/DC Adapter from wall outlet.

# OPERATIONS

## General Operation:

1. Recharged the built-in battery as previously instructed. (To check the power of the battery, press the BATTERY METER Button on the top of unit.)
2. Press the Power ON-OFF Switch to ON position on the right of unit to turn the unit to standby mode. The POWER Indicator on the top of unit will illuminate.
3. Press and hold the  $\cup$ /MODE Button on the top of unit approximately 1 second until "ON" appear on the LED Display to turn on the unit from standby mode. The LED Display will illuminate.
4. Press the  $\cup$ /MODE Button repeatedly to switch to desired playback mode. The correspondent indicator will appear on the display with your selection (see list below):

Playback Mode:	Indicators:
BT (Bluetooth)	"bt" will appear on the display
USB (If USB Device inserted)	"USb" will appear on display
Radio FM Band	Radio frequency "XX.X" or "XXX.X" will appear on the display
AUX IN	"AUX" will appear on the display

5. During playback,
  - A. Turn the Volume Control Knob on the top of unit to adjust volume level as desired.
  - B. Press the LIGHT Button repeatedly to turn ON/OFF or change the blinking mode of the Decorative LED Lights.
6. When finished listening, press the  $\cup$ /MODE Button to turn the unit to Standby Mode.
7. If you will not use the unit for an extended period of time, power off the unit by press the Power ON-OFF Switch to OFF position. The POWER Indicator will not light.

## IMPORTANT:

**The design of this unit is for Water and Dusts Ingress Protective; always make sure all the covers were completely closed tightly and firmly.**

## **BT MODE:**

### **BT (Bluetooth) pairing:**

First time use or re-pairing the unit to a new BT Device, pair as follows:

1. Power on the unit and enter to BT mode as previously instructed. "bt" will appear on the display and blink.
2. Power on the external BT Device and enter to BT searching mode. Start pairing following the on screen instructions from the external BT Device. After paired, the "bt" Indicator on the display will stop blinking.
3. If pairing is complete you may now play music with your external BT Device.
4. During playback:
  - Press the ►| Button on the unit to pause, press again to resume normal playback.
  - Press the ◀◀ or ▶▶ Buttons repeatedly to skip tracks.

### **Notes:**

- When the external BT Device searched the unit, our model number " MHT833 " will appear on the display of external BT Device.
- If while pairing you are asked for a code please try " 0000 " or " 1234 " .

### **Normal operation after pairing:**

1. Power on the external BT Device and enter to BT mode.
2. Power on the unit and enter to BT mode as previously instructed. " bt " will appear on the display and blink.
3. Wait a few seconds until the unit is automatically paired to the external BT Device. The " bt " indicator on the display will stop blinking.
4. After pairing is complete you may now play music with your external BT Device.



### **USB DEVICE PLAYBACK MODE:**

To play the music in USB Device:

1. In power off mode, insert the USB Device into the USB Port on the right of unit as the illustrated below:

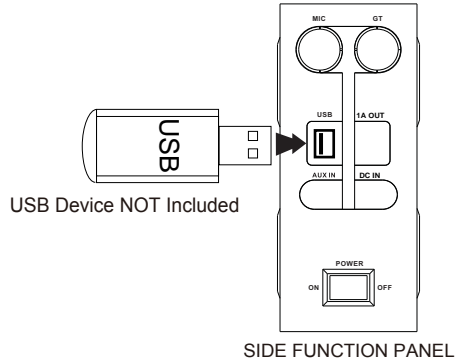







2. Power on the unit as previously instructed.
3. Press the  $\odot$ /MODE Button repeatedly until "USB" appear on the LED Display. Play will start automatically.
4. During playback:
  - Press the  $\blacktriangleright\parallel$  Button to pause, press again to resume normal playback.
  - Press the  $\blacktriangleleft\blacktriangleleft$  or  $\blacktriangleright\blacktriangleright$  Buttons repeatedly to skip tracks.
  - Press and holding the  $\blacktriangleleft\blacktriangleleft$  or  $\blacktriangleright\blacktriangleright$  Buttons to search the specific section.

#### **Notes:**

- Up to 64 GB USB Device the unit supports to play.
- Before replacing USB Device, make sure the unit has been powered off.
- When inserting the USB Device, make sure the direction you selected is correct. Never insert violently to avoid damaging the USB Device or the unit.
- You also need to download the desired music in MP3 format into the USB Device before insert into the unit.

### **FM RADIO:**

1. Power on the unit as previously instructed.
2. Press the /MODE Button repeatedly until radio frequency appear on the display.
3. Press and hold the  or  Buttons until the radio frequency on the display start running to automatically search and play the previous/next available FM station. Repeat the same procedures until the desired FM station was been searched and play. Or,
4. Preset and play:
  - Receiving the desired FM station, press M (Memory) Button until “CH XX” appear on the display.
  - Press the  or  Buttons repeatedly to the desired channel you want to store in.
  - Press the M (Memory) Button to store the desired FM station into the selected channel.
  - Repeat the same procedures until all desired FM stations (Up to 20 stations) are stored.
  - Press the  Button repeatedly to plays the desired stored channels.

### **Antennas:**

This unit has a built in FM antenna, which provides adequate reception in most areas. If reception is weak, reassemble the other direction/location to improve reception.

### **AUX IN MODE:**

To listen from an external Audio Player such as a MP3 Player, Discman ...etc.

1. Connect one end of the supplied Audio Connection Cable to the AUX Out/Line Out/Phone Jack on the external Audio Player.
2. Connect the other end of the cable to the AUX IN Jack on the right of unit as the illustrated below:

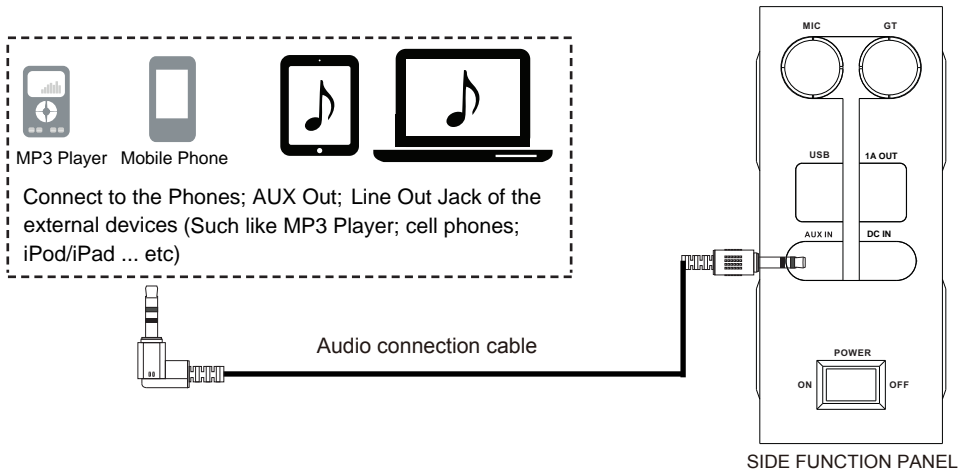

3. Power on the unit as previously instructed.
4. Press the /MODE Button repeatedly until “AUX” appear on the display.
5. Play the music on the connected Player as usual. (Make sure the volume level of the connected Audio Player is turned to high level.)

### **SING WITH PLAYING MUSIC:**

To sing with the playing music:

1. Power on the unit and play music in any modes as instructed earlier.
2. Connect the plug from supplied Microphone to the MIC (Microphone) Jack on the right of unit.
3. Turn the MIC VOLUME (Microphone Volume) Control Knob to adjust the sound level of microphone.
4. Turn the MIC ECHO (Microphone Echo) Control Knob to adjust the echo effect of microphone.

Note: If feedback noise (high audio frequency noise) is hearing from the speakers, turn the MIC VOL (Microphone Volume) Knob counterclockwise to reduce the microphone volume level or keep the Microphone away from the speakers.

### **PLAY ELECTRIC GUITAR WITH PLAYING MUSIC:**

To play the Electric Guitar with the playing music:

1. Power on the unit and play music in any modes as instructed earlier.
2. Connect the plug from Electric Guitar (Not included) to the GT (Electric Guitar) Jack on the right of unit.
3. Turn the GT VOLUME (Electric Guitar Volume) Control Knob to adjust the sound level of Electric Guitar.

### **BUILT-IN 1A USB CHARGER:**

To charging the external USD Device:

1. Make sure the unit is in power on or standby mode.
2. Connect the full size USB Plug from the external USB Device to the 1A USB Port on the right of unit. Charging will start automatically.
3. When finished charge, disconnect the external USB Device from the 1A USB Port.

Notes:

- A. Before charge the external USB Device, check the power of the built-in battery. If the power of the battery is too low, it cannot use to charge the external USB Device.
- B. The Charger has a built-in overload/overheats protector. If the output of the Charger is overload. It will shut off automatically. Unplug the external USB Device from the 1A USB Port. The Charge will auto reset.

**Retractable Handle:**

Press the button on the top of the handle to release the lock then pull it out or back as the illustrated below:

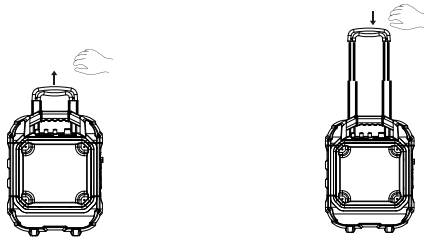

## TROUBLESHOOTING GUIDE





**Check the follows before requesting service:**

SYMPTOM	POSSIBLE CAUSE	POSSIBLE SOULTION
No power	Power Switch is in OFF position	Press the POWER ON-OFF Switch on the right of unit to ON position
	Built-in rechargeable battery drained	Recharge the built-in battery
No Sound	Volume in minimum position	Rise volume level by turning the VOLUME Control Knob clockwise
	The connected/paired device is not in playback mode	Plays the audio/video files in the connected/paired device as usual
	Sound output of the connected/paired device too low	Rise the volume level of the connected /paired device
	Play mode incorrect	Press the MODE/ ⏪ Button repeatedly to set or reset the play mode as the connection
Sound distortion	Volume level too high	Reduce the volume level by turning the VOLUME Control Knob counterclockwise
	Volume level of the connected /paired device too high	Reduce the volume and/or bass level of the connected /paired device
BT not function	The external BT device too far from the unit	Place the external BT device close to the unit
Built-in battery cannot be recharge.	The unit is not in powered on or standby mode	Press the POWER ON-OFF Switch to ON position to turn the unit to standby mode



## CLEANING

1. To prevent fire or shock hazard, disconnect your unit from the AC/DC Adapter when cleaning.
2. The finish on your unit may be cleaned with a dust cloth and cared for as other furniture.  
Use caution when cleaning and wiping the plastic parts.
3. Mild soap and a damp cloth may be used.

## GENERAL SPECIFICATIONS

Power Source:	Built-in rechargeable DC  12V, 4000mAh (48 WH) Sealed Lead Acid battery; Recharge by DC  15V, 2A,  
Water/Dust Ingress Protective Level:	IP44
Radio FM Band Coverage:	87.5-108MHz
Audio Power:	20W
Impedance of Speakers:	Loud Speaker: 1 X 3 Ohms, 45W Tweeter: 1 X 8 Ohms, 12W
BT Version:	4.1
BT Effective Range:	Up to 32 Feet in open area

## ACCESSORIES

- 1 x User's Manual
- 1 x AC/DC Adapter ( Input: AC 100-240~; 50/60Hz; 0.8A Max.  
Output: DC  15V, 2A,   )
- 1 x Microphone
- 1 x Audio Connection Cable with 3.5mm Plugs

**SPECIFICATIONS AND ACCESSORIES ARE SUBJECT TO CHANGE WITHOUT NOTICE**

## LIMITED WARRANTY

Craig Electronics Inc. warrants this product to be free from manufacturing defects in material and workmanship under normal use for a period of 180 days from date of purchase. If service is required, please return the product to the store where it was purchased for exchange; or, pack the unit in the original packing material with all accessories if applicable, a copy of your sales receipt and a Cashier's check or Money Order for \$20 (to cover shipping and handling costs) payable to Craig Electronics Inc. For consumers in Canada, please make sure that the cashier check or money order is redeemable through a U.S. bank. Ship your product freight pre-paid. Your unit will be repaired, replaced or if the unit can not be repaired or replaced, a refund will be forwarded to you within four weeks of receipt of your unit. Please ship your unit to:

Craig Electronics Inc.  
1160 NW 163 Drive  
Miami, FL 33169

This warranty is void if the product has been: a) Used in a commercial application or rental. b) Damaged through misuse, negligence, or abuse. c) Modified or repaired by anyone other than an authorized Craig Electronics Inc. service center. d) Damaged because it is improperly connected to any other equipment.

Note: This warranty does not cover: a) Ordinary adjustments as outlined in the Owner's Manual which can be performed by the customer. b) Damage to equipment not properly connected to the product. c) Any cost incurred in shipping the product for repair. d) Damage to the product not used in the USA.

This warranty is not transferable and only applies to the original purchase. Any implied warranties, including the warranty of merchantability, are limited in duration to the period of this expressed warranty and no warranty whether expressed or implied shall apply to the product thereafter.

Under no circumstance shall Craig Electronics Inc. be liable for any loss or consequential damage arising out of the use of this product. This warranty gives specific legal rights. However, you may have other rights which may vary from state to state. Some states do not allow limitations on implied warranties or exclusion of consequential damage. Therefore, these restrictions may not apply to you.

This product has been manufactured by and is sold under the responsibility of Craig Electronics Inc., and Craig Electronics Inc. is the warrantor in relation to this product. MAGNAVOX and SMART. VERY SMART are registered trademarks of Koninklijke Philips N.V. and are used under license from Koninklijke Philips N.V.

To Obtain Service on your Product  
email: [service@craigelectronics.com](mailto:service@craigelectronics.com)