



MAGNAVOX

CD BOOMBOX

with AM/FM Radio and
Bluetooth® Wireless Technology



OWNER'S MANUAL

PLEASE READ BEFORE OPERATING THIS EQUIPMENT.

MODEL: MD6949

Size: 148.5(W) x 210(H)mm (A5)

IMPORTANT SAFETY INSTRUCTION

	CAUTION RISK OF ELECTRIC SHOCK DO NOT OPEN	
CAUTION: TO REDUCE THE RISK OF ELECTRIC SHOCK, DO NOT REMOVE COVER (OR BACK). NO USER-SERVICEABLE PARTS INSIDE. REFER SERVICING TO QUALIFIED SERVICE PERSONNEL.		



DANGEROUS VOLTAGE:

The lightning flash with arrowhead symbol, within an equilateral triangle is intended to alert the user to the presence of uninsulated dangerous voltage within the product's enclosure that may be of sufficient magnitude to constitute a risk of electric shock to persons.



ATTENTION:

The exclamation point within an equilateral triangle is intended to alert the user to the presence of important operating and maintenance (servicing) instructions in the literature accompanying the appliance.

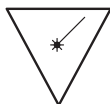

DANGER

Invisible and hazardous laser radiation when open and inter-lock failed or defeated. Avoid direct exposure to beam.

FCC WARNING: This equipment may generate or use radio frequency energy. Changes or modifications to this equipment may cause harmful interference unless the modifications are expressly approved in the instruction manual. Modifications not authorized by the manufacturer may void users authority to operate this device.
--

WARNING: TO REDUCE THE RISK OF FIRE OR ELECTRIC SHOCK, DO NOT EXPOSE THIS PRODUCT TO RAIN OR MOISTURE. TO REDUCE THE RISK OF FIRE OR ELECTRIC SHOCK, AND ANNOYING INTERFERENCE, USE THE RECOMMENDED ACCESSORIES ONLY.
--

LASER SAFETY : This unit employs a laser. Only qualified service personnel should attempt to service this device due to possible eye injury.

CAUTION : USE OF CONTROLS, ADJUSTMENTS OR PERFORMANCE PROCEDURE HERENIN MAY RESULT IN HAZARDOUS RADIATION EXPOSURE.

INFORMATION:

This equipment has been tested and found to comply with the limits for a Class B digital device, pursuant to Part 15 of the FCC Rules. These limits are designed to provide reasonable protection against harmful interference in a residential installation. This equipment generates, uses and can radiate radio frequency energy and, if not installed and used in accordance with the instructions, may cause harmful interference to radio communications. However, there is no guarantee that interference will not occur in a particular installation. If this equipment does cause harmful interference to radio or television reception, which can be determined by turning the equipment off and on, the user is encouraged to try to correct the interference by one or more of the following measures:

- Reorient or relocate the receiving antenna.
- Increase the separation between the equipment and receiver.
- Connect the equipment into an outlet on a circuit different from that to which the receiver is connected.
- Consult the dealer or an experienced radio/TV technician for help.

IMPORTANT SAFETY INSTRUCTION

Before using the unit, be sure to read all operating instructions carefully. Please note that these are general precautions and may not pertain to your unit. For example, this unit may not have the capability to be connected to an outdoor antenna.

1) Read these instructions.

All the safety and operating instructions should be read before the product is operated.

2) Keep these instructions.

The safety and operating instructions should be retained for future reference.

3) Heed all warnings.

All warnings on the product and in the operating instructions should be adhered to.

4) Follow all instructions.

All operating and use instructions should be followed.

5) Do not use this apparatus near water.

Do not use this product near water and moisture, for example: near a bathtub, washbowl, kitchen sink or laundry tub; in a wet basement; or near a swimming pool.

6) Clean only with dry cloth.

Unplug this product from the wall outlet before cleaning. Do not use liquid cleaners or aerosol cleaners. Use a dry cloth for cleaning.

7) Do not block any ventilation openings. Install in accordance with the manufacturer's instructions.

Slots and openings in the cabinet and in the back or bottom are provided for ventilation, to ensure reliable operation of the product and to protect it from overheating. These openings must not be blocked or covered. The openings should never be blocked by placing the product on a bed, sofa, rug or other similar surface. This product should never be placed near or over a radiator or heat source. This product should not be placed in a built-in installation such as a bookcase or rack unless proper ventilation is provided or the manufacturer's instructions have been adhered to.

8) Do not install near any heat sources such as radiators, heat registers, stoves, or other apparatus (including amplifiers) that produce heat.

9) Do not defeat the safety purpose of the polarized or grounding-type plug.

A polarized plug has two blades with one wider than the other. A grounding type plug has two blades and a third grounding prong. The wide blade or the third prong is provided for your safety. If the provided plug does not fit into your outlet, consult an electrician for replacement of the obsolete outlet.

10) Protect the power cord from being walked on or pinched particularly at plugs, convenience receptacles, and the point where they exit from the apparatus.

11) Only use attachments/accessories specified by the manufacturer.

12) Use only with the cart, stand, tripod, bracket, or table specified by the manufacturer, or sold with the apparatus. When a cart is used, use caution when moving the cart/apparatus combination to avoid injury from tip-over.



An appliance and cart combination should be moved with care.

Quick stops, excessive force and uneven surfaces may cause the appliance and cart combination to overturn.

IMPORTANT SAFETY INSTRUCTION

13) Unplug this apparatus during lightning storms or when unused for long periods of time.

To protect your product from a lightning storm, or when it is left unattended and unused for long periods of time, unplug it from the wall outlet and disconnect the antenna or cable system. This will prevent damage to the product due to lightning and power-line surges.

14) Refer all servicing to qualified service personnel. Servicing is required when the apparatus has been damaged in any way, such as power-supply cord or plug is damaged, liquid has been spilled or objects have fallen into the apparatus, the apparatus has been exposed to rain or moisture does not operate normally, or has been dropped.

15) Power source

This product should be operated only from the type of power source indicated on the marking label. If you are not sure of the type of power supply to your home, consult your appliance dealer or local power company. For products intended to operate from battery power, or other source, refer to the operation instructions.

16) Power lines

An outside antenna system should not be located in the vicinity of overhead power lines or other electric light or power circuits, or where it can fall into such power lines or circuits. When installing an outside antenna system, extreme care should be taken to keep from touching such power lines or circuits as contact with them might be fatal.

17) Overloading

Do not overload wall outlets and extension cords as this can result in a risk of fire or electric shock.

18) Object and liquid entry

Never push objects of any kind into this product through openings as they may touch dangerous voltage points or short out parts that could result in fire or electric shock. Never spill or spray any type of liquid on the product.

19) Outdoor antenna grounding

If an outside antenna is connected to the product, be sure the antenna system is grounded so as to provide some protection against voltage surges and built up static charges. Section 810 of the National Electric Code ANSI/NFPA 70 provides information with respect to proper to grounding of the mast and supporting structure, grounding of the lead-in wire to an antenna discharge product, size of grounding conductors, location of antenna-discharge product, connection to grounding electrodes and requirements for the grounding electrodes.

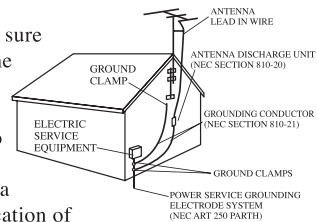

20) Service

Do not attempt to service this product yourself as opening or removing covers may expose you to dangerous voltage or other hazards. Refer all servicing to qualified service personnel.

IMPORTANT SAFETY INSTRUCTION

21) Replacement parts

When replacement parts are required, be sure the service technician uses replacement parts specified by the manufacturer or those that have the same characteristics as the original parts. Unauthorized substitutions may result in fire or electric shock or other hazards.

22) Safety check

Upon completion of any service or repairs to this product, ask the service technician to perform safety checks to determine that the product is in proper operation condition.

23) Wall or ceiling mounting

The product should be mounted to a wall or ceiling only as recommended by the manufacturer.

24) Damage requiring service

Unplug this product from the wall outlet and refer service to qualified service personnel under the following conditions.

- a) When the power-supply cord or plug is damaged.
- b) If liquid has been spilled or objects have fallen into the product.
- c) If the product has been exposed to rain or water.
- d) If the product does not operate normally by following the operating instructions. Adjust only those controls that are covered by the operating instructions, as an adjustment of other controls may result in damage and will require extensive work by a qualified technician to restore in the product to its normal operation.
- e) If the product has been dropped or the cabinet has been damaged.
- f) When the product exhibits a distinct change in performance-this indicates a need for service.

25) Note to CATV system installer

This reminder is provided to call the CATV system installer's attention to Article 820-40 of the NEC that provides guidelines for proper grounding and, in particular, specifies that the cable ground shall be connected to the grounding system of the building, as close to the point of cable entry as practical.

NOTE: Refer all servicing to qualified service personnel. Servicing is required when the unit has been damaged in any way such as the following: the power-supply cord or plug has been damaged, liquid has been spilled into the unit, the unit has been exposed to rain or moisture, the unit has been dropped or the unit does not operate normally.

POWER SOURCE:

This unit can be powered by either AC power or six (6) “C” size batteries (not included) as below:

AC Operation:

To operate the unit using AC power, connect the small plug from the supplied AC Cord to the AC IN Jack on the rear of unit. Plug the AC Cord to the AC wall outlet having AC 120V~, 60 Hz as illustrated below.

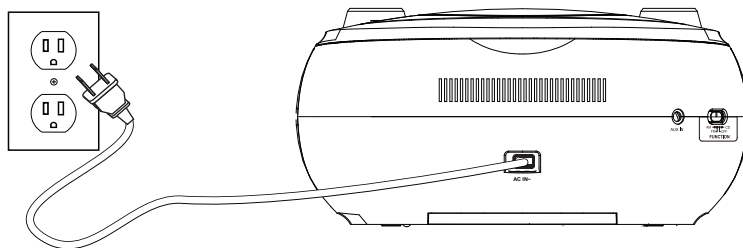

Notes:

- This AC Cord is equipped with a polarized AC plug which has one blade wider than the other. This is a safety feature to reduce the likelihood of electric shock. This polarized AC plug will only fit in a polarized AC outlet.
If you find that you cannot insert this plug in your outlet, you may have an obsolete non-polarized outlet. Please do not try to defeat this safety feature by using a non-polarized adaptor or by filling the wider blade to make it fit into your outlet.
- If this plug does not fit into your outlet, you should contact a qualified licensed electrician to replace your obsolete outlet.
- If long period of time will not use the unit. Unplug the AC Cord from wall outlet.

Battery Operation:

Install (or replace the batteries when it is drained) as below

1. Slide the Battery Door (on the bottom of unit) out then lift it off.
2. Insert six (6) “C” size batteries (not included) according to the polarity diagram inside the battery compartment.
3. Replace the battery door.

Note:

When the AC plug was inserted into the AC IN Jack, the battery power will be cut off automatically. To use battery power, make sure the plug was detached off from the AC IN Jack. Otherwise, the unit can NOT be powered on.

BATTERY PRECAUTIONS:

Follow these precautions when using a battery in this device:

1. Use only the size and type of battery specified.
2. Be sure to follow the correct polarity when installing the battery as indicated in the battery compartment.
A reversed battery may cause damage to the device.
3. Do not mix different types of batteries together (e.g. Alkaline and Carbon-zinc) or old batteries with fresh ones.
4. If the batteries in the device are consumed or the device is not to be used for a long period of time, remove the batteries to prevent damage or injury from possible battery leakage.
5. Do not try to recharge the battery not intended to be recharged; it can overheat and rupture. (Follow battery manufacturer’s instructions.)
6. Do not dispose of battery in fire. Battery may explodes or leak.
7. Clean the battery contacts and also those of the device prior to battery installation.

LOCATION OF CONTROLS

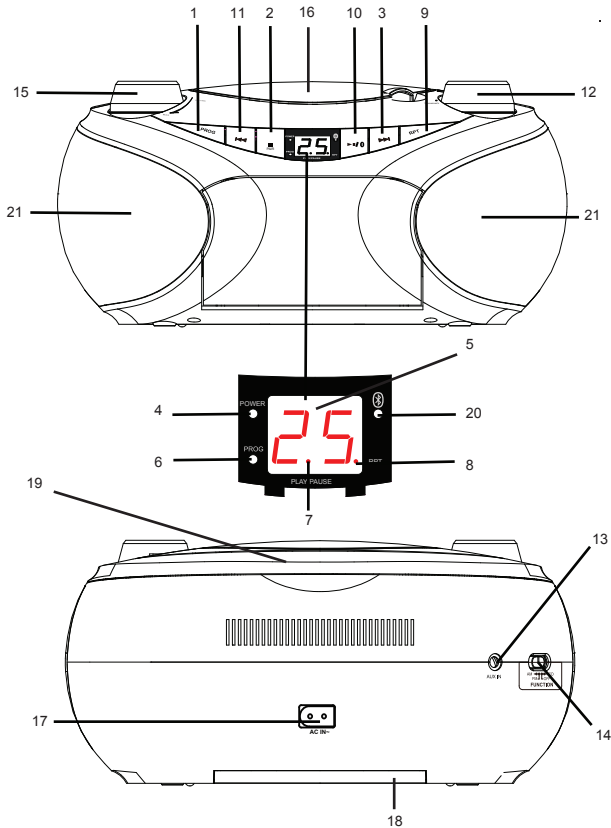

1. **PROG** (Program) Button
2. ■ (Stop) Button
3. ►► (Skip/Fast Search Forward) Button
4. **POWER** Indicator
5. LED Display
6. **PROG** (Program) Indicator
7. **PLAY/PAUSE** Indicator
8. **RPT** (Repeat) Indicator
9. **RPT** (Repeat) button
10. ►|| / BT (Play/Pause/Bluetooth) Button
11. ◀◀ (Skip/Fast Search Backward) Button
12. **TUNING** Knob
13. **AUX IN** Jack
14. **AM-FM-OFF(Power)-CD/BT/AUX IN** Function Selector
15. **VOLUME** Control Knob
16. CD Door
17. **AC IN** ~ Jack
18. Battery Compartment (On the bottom)
19. Carry Handle
20. BT (Bluetooth) Indicator
21. Speakers

OPERATION

RADIO:

1. Slide the Function Selector to **AM** or **FM** position to turn on the radio and set to desired band. The **POWER** Indicator will illuminate.
2. Turn the TUNING Knob to receive the desired radio station.
3. Turn the VOLUME Control Knob to adjust volume level as desired.
4. When finished listening, slide the FUNCTION Selector to OFF position to shut off the unit. The POWER Indicator will turn off.

Antenna:

This unit has a built-in AM/FM antenna, which provides adequate reception in most areas. If reception is weak, turn the unit to improve reception.

CD:

1. Slide the Function Selector to **CD/BT/AUX IN** position to turn on the CD.
 - The **POWER** Indicator will illuminate.
 - The LED Display will illuminate and indicate "--" then "no" will appear.
2. Open the CD Door then place a CD disc on the center spindle, with the printed side faced up.
3. Close the CD door. Wait a few seconds; the number of the total tracks will appear on the LED Display.
4. Press the ►|| /BT Ⓢ (Play/Pause/BT) Button to start playback the first track on the disc. The **PLAY/PAUSE** Indicator will illuminate.
5. During playback:
 - Turn the **VOLUME** Control Knob to adjust volume level as desired.
 - Press the ►|| /BT Ⓢ (Play/Pause/BT) Button to pause, the **PLAY/PAUSE** Indicator will start blinking. Press the button again to resume normal playback, the **PLAY/PAUSE** Indicator will stop blinking.
 - Press the ◀◀ or ▶▶ Buttons repeatedly to skip the tracks.
 - Press and hold the ◀◀ or ▶▶ Buttons to fast search the specific section then release the button to play.
6. To stop CD playback, press the ■ (Stop) Button. The total number of tracks will appear on the display.
7. When finished listening, slide the Function Selector to **OFF** position to shut off the unit. The **POWER** Indicator will turn off.

Programmed Playback:





Up to 20 tracks can be programmed playback as follows:

1. In CD stop playback mode, press the **PROG** (Program) Button. "01" will appear on the display and blink. The **PROG** (Program) Indicator will illuminate and blink too.
2. Select the first specific track to be programmed by pressing the ◀◀ or ▶▶ Buttons repeatedly.
3. Press the **PROG** (Program) Button to store the selected track into the memory.
4. Repeat steps 2 and 3 until all the specific tracks stored into the memory.
5. Press the ►|| /BT Ⓢ (Play/Pause/BT) Button to start program playback. The **PROG** (Program) Indicator will stop blinking.
6. To stop program playback, press the ■ (Stop) Button. Press the ►|| /BT Ⓢ (Play/Pause/BT) Button again to resume program playback.
7. To erase the program, press the ■ (Stop) Button again in stop mode. The **PROG** (Program) Indicator will turn off.

Repeat/Random Playback:

1. During playback (or program playback), press the **RPT** (Repeat) Button once. The **RPT** (Repeat) Indicator will illuminate and blink. The current track will playback repeatedly.
2. During playback (or program playback), press the **RPT** (Repeat) Button twice. The **RPT** (Repeat) Indicator will illuminate and stop blink. All the tracks on the current disc (or program) will be playback repeatedly.
3. To cancel the repeat playback, press the **RPT** (Repeat) Button repeatedly until the **RPT** (Repeat) Indicator is turn off.

BT (Bluetooth):**For first time use or re-pairing the unit to a new BT Device, follow instructions below:**



1. Slide the Function Selector to **CD/BT/AUX IN** position to turn on the CD.
 - The **POWER** Indicator will illuminate.
 - The LED Display will illuminate and indicate "--" then "no" will appear.
2. Press and hold the ▶|| /BT  (Play/Pause/BT) Button until "bt" appear on the display and blink to enter to BT mode.
The BT  (Bluetooth) Indicator will illuminate and blink too.
3. Power on the external BT Device and enter to BT searching mode. Start pairing following the on screen instructions from the external BT Device. When paired, the LED display and BT  (Bluetooth) Indicator will stop blinking.
4. If pairing is complete you may now play music with your external BT Device.
5. During playback:
 - Turn the **VOLUME** Control Knob to adjust volume level as desired.
 - Press the ▶|| /BT  (Play/Pause/BT) Button to pause; press again to resume normal playback.
 - Press the ⏮ or ⏭ Buttons repeatedly to skip the tracks.
6. When finished listening, slide the Function Selector to **OFF** position to shut off the unit. The **POWER** Indicator will turn off.

Notes:

When the external BT Device searches for the unit, our model number "MD6949" will appear on the display of external BT Device.

If while pairing you are asked for a code please try "0000" or "1234".

Normal operation after pairing:

1. Power on the external BT Device and enter to BT mode.
2. Slide the Function Selector to CD/BT/AUX IN position to turn on the CD.
 - The **POWER** Indicator will illuminate.
 - The LED Display will illuminate and indicate "--" then "no" will appear.
3. Press and hold the ▶|| /BT  (Play/Pause/BT) Button until "bt" appear on the display and blink to enter to BT mode.
The BT  (Bluetooth) Indicator will illuminate and blink too.
4. Wait a few seconds until the unit automatically pairs to the BT Device. The LED display and BT (Bluetooth) Indicator will stop blinking.
5. If pairing is complete you may now play music and answer the phone with your external BT Device.
6. When finished listening, slide the Function Selector to **OFF** position to shut off the unit. The **POWER** Indicator will turn off.

AUX IN:

1. Insert one end of the Audio Connect Cable (not included) to the AUX Out; Line Out or Phones Jack on the external Audio Player.
2. Insert the other end to the AUX IN Jack on the rear of unit.
3. Slide the Function Selector to **CD/BT/AUX IN** position to turn on the unit. The **POWER** Indicator will illuminate and the unit will automatically switch to AUX IN mode.
4. Play the music on the connected external Audio Player as usual.
5. Turn the **VOLUME** Control Knob to adjust volume level as desired.
6. When finished listening, slide the Function Selector to **OFF** position to shut off the unit. The **POWER** Indicator will turn off.

NOTES:

- If the Audio Connection Cable was inserted into the AUX IN Jack, CD/BT will not function. Disconnect the cable from the AUX IN Jack before use CD/BT.
- Make sure the sound output level of the connected external Audio Player is in high level. Otherwise, sound will be weak.
- If sound is distorting, reduce the volume of the connected external Audio Player or set the EQ mode of it to normal.

CARE AND MAINTENANCE

Caring for Compact Discs

- Treat the disc carefully. Handle the disc only by its edges. Never allow your fingers to come in contact with the shiny, unprinted side of the compact disc.
- Do not attach adhesive tape, stickers, etc. to the compact disc label.
- Clean the compact disc periodically with a soft, lint-free, dry cloth. Never use detergents or abrasive cleaners to clean the compact disc. If necessary, use a CD cleaning kit.
- If a compact disc skips or gets stuck on a section of the compact disc, it is probably dirty or damaged (scratched).
- When cleaning the compact disc, wipe in straight lines from the centre of the compact disc to the outer edge of the compact disc. Never wipe in circular motions.

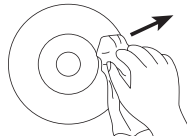
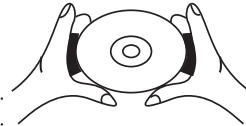

- This unit is designed to play only compact discs bearing the identification logo as shown here. Other discs may not conform to the CD standard and may not play properly.
- Compact Discs should be stored in their cases after each use to avoid damage.
- Do not expose compact discs to direct sunlight, high humidity, high temperatures or dust, etc. Prolonged exposure or extreme temperatures can warp the disc.
- Do not stick or write anything on either side of the disc. Sharp writing instruments, or the ink, may damage the surface.



Cleaning the Unit

- To prevent fire or shock hazard, disconnect your unit from the AC power source when cleaning.
- The finish on your unit may be cleaned with a dust cloth and cared for as other furniture. Use caution when cleaning and wiping the plastic parts.
- Mild soap and a damp cloth may be used on the front panel.

TROUBLESHOOTING

Check the following before requesting service:

SYMPTOM	POSSIBLE CAUSE	POSSIBLE SOLUTION
No power	AC Power cord had not connected	Connect the AC Cord to the rear of unit and any wall outlet having AC 120V~; 60Hz
Cannot use battery power	The batteries was drained	Replace by new batteries
	The AC Cord was inserted into the AC IN Jack	Disconnect the AC Cord from the AC IN Jack
No sound or sound weak	Volume of the unit was set to minimum position	Increase the volume level by turning the VOLUME Control Knob clockwise
	Volume level of paired/connected external Audio Player is in low level	Rise the volume level of the paired/connected external Audio Player
Sound distortion	Volume level too high	Reduce the volume level by turning the VOLUME Control Knob counterclockwise
	Volume level of the paired/connected external Audio Player too high	Reduce the volume level of the paired/connected external Audio Player
CD not functioning	Audio Connection Cable was inserted into the AUX IN Jack	Disconnect the cable from AUX IN Jack
	Disc is dirty or scratched	Try other discs
	CD disc incorrect install	Place the CD disc on the center spindle with printed side face up
BT not functioning	Audio Connection Cable was inserted into the AUX IN Jack	Disconnect the cable from AUX IN Jack
	The external BT Device had NOT paired to the unit	Pair the external BT Device to the unit as page 8
	The external BT Device too far from the unit	Place the external BT Device close to the unit

GENERAL SPECIFICATIONS

Power Source:	AC 120 V~; 60 Hz; 14 W, Or DC 9 V; 6 x "C" size batteries (Not included)
BT Version:	2.1
Radio Frequency:	AM: 535 - 1710 kHz FM: 87.5 - 108 MHz
Disc Compatible:	CD; CD-R; CD-RW
Impedance of Speakers:	2 x 2 W; 8 Ω
Audio power:	1 W per Channel (Total 2W, RMS)

ACCESSORIES

- 1 x Owner's Manual
- 1 x AC Power Cord

SPECIFICATIONS AND ACCESSORIES ARE SUBJECT TO CHANGE WITHOUT NOTICE

LIMITED WARRANTY

Craig Electronics warrants this product to be free from manufacturing defects in material and workmanship under normal use for a period of 180 days from date of purchase. If service is required, please return the product to the store where it was purchased for exchange; or, pack the unit in the original packing material with all accessories if applicable, a copy of your sales receipt and a Cashier's check or Money Order for \$10 (to cover shipping and handling costs) payable to Craig Electronics Inc. For consumers in Canada, please make sure that the cashier check or money order is redeemable through a U.S. bank. Ship your product freight pre-paid. Your unit will be repaired, replaced or if the unit cannot be repaired or replaced, a refund will be forwarded to you within four weeks of receipt of your unit. Please ship your unit to:

Craig Electronics Inc.
1160 NW 163 Drive
Miami, FL 33169

This warranty is void if the product has been: a) Used in a commercial application or rental. b) Damaged through misuse, negligence, or abuse. c) Modified or repaired by anyone other than an authorized Craig service center. d) Damaged because it is improperly connected to any other equipment.

Note: This warranty does not cover: a) Ordinary adjustments as outlined in the Owner's Manual which can be performed by the customer. b) Damage to equipment not properly connected to the product. c) Any cost incurred in shipping the product for repair. d) Damage to the product not used in the USA.

This warranty is not transferable and only applies to the original purchase. Any implied warranties, including the warranty of merchantability, are limited in duration to the period of this expressed warranty and no warranty whether expressed or implied shall apply to the product thereafter.

Under no circumstance shall Craig be liable for any loss or consequential damage arising out of the use of this product. This warranty gives specific legal rights. However, you may have other rights which may vary from state to state. Some states do not allow limitations on implied warranties or exclusion of consequential damage. Therefore, these restrictions may not apply to you.

This product has been manufactured by and is sold under the responsibility of Craig Electronics Inc, and Craig Electronics Inc is the warrantor in relation to this product. MAGNAVOX and SMART. VERY SMART are registered trademarks of Koninklijke Philips N.V. and are used under license from Koninklijke Philips N.V.

To Obtain Service on your Product
email: service@craigelectronics.com