



MAGNAVOX

7 INCH PORTABLE DVD PLAYER **with Swivel Screen Display**

Owner's Manual



PLEASE READ BEFORE OPERATING THIS EQUIPMENT.

Model: MTFT716n

Size: 148.5(W) x 210(H)mm (A5)



IMPORTANT SAFETY INSTRUCTION

	CAUTION RISK OF ELECTRIC SHOCK DO NOT OPEN	
<p>CAUTION: TO REDUCE THE RISK OF ELECTRIC SHOCK, DO NOT REMOVE COVER (OR BACK). NO USER-SERVICEABLE PARTS INSIDE. REFER SERVICING TO QUALIFIED SERVICE PERSONNEL.</p>		

CAUTION:
THIS DIGITAL VIDEO DISC PLAYER EMPLOYS A LASER SYSTEM.
TO ENSURE PROPER USE OF THIS PRODUCT, PLEASE READ THIS OWNER'S MANUAL CAREFULLY AND RETAIN FOR FUTURE REFERENCE. SHOULD THE UNIT REQUIRE MAINTENANCE, CONTACT AN AUTHORIZED SERVICE LOCATION-SEE SERVICE PROCEDURE.
USE CONTROLS, ADJUSTMENTS OR THE PERFORMANCE OF PROCEDURES OTHER THAN THOSE SPECIFIED HEREIN MAY RESULT IN HAZARDOUS RADIATION EXPOSURE.
TO PREVENT DIRECT EXPOSURE TO LASER BEAM, DO NOT TRY TO OPEN THE ENCLOSURE. VISIBLE LASER RADIATION MAY BE PRESENT WHEN THE ENCLOSURE IS OPENED. DO NOT STARE INTO BEAM.

WARNING:
TO REDUCE THE RISK OF FIRE OR ELECTRIC SHOCK, DO NOT EXPOSE THIS PRODUCT TO RAIN OR MOISTURE.

WARNING:
TO REDUCE THE RISK OF FIRE OR ELECTRIC SHOCK, AND ANNOYING INTERFERENCE, USE THE RECOMMENDED ACCESSORIES ONLY.



The lightning flash with arrowhead symbol within an equilateral triangle is intended to alert the user to the presence of uninsulated dangerous voltage within the product's enclosure that may be of sufficient magnitude to constitute a risk of electric shock to persons.



The exclamation point within an equilateral triangle is intended to alert the user to the presence of important operating and maintenance(servicing) instructions in the literature accompanying the appliance.



DANGER:
Invisible and hazardous laser radiation when open and interlock failed or defeated. Avoid direct exposure to beam.

FCC NOTICE:

This equipment has been tested and found to comply with the limits for a Class B digital device, pursuant to part 15 of the FCC Rules. These limits are designed to provide reasonable protection against harmful interference in a residential installation. This equipment generates, uses and can radiate radio frequency energy and, if not installed and used in accordance with the instructions, may cause harmful interference to radio communications.

However, there is no guarantee that interference will not occur in a particular installation. If this equipment does cause harmful interference to radio or television reception, which can be determined by turning the equipment off and on, the user is encouraged to try to correct the interference by one or more of the following measures:

- Reorient or relocate the receiving antenna.
- Increase the separation between the equipment and receiver.
- Connect the equipment into an outlet on a circuit different from that to which the receiver is connected.
- Consult the dealer or an experienced radio/TV technician for help.

FCC WARNING:

To assure continued compliance, follow the attached installation instructions and use only shielded cables when connecting to other devices. Modifications not authorized by the manufacturer may void user's authority to operate this device.

IMPORTANT SAFETY INSTRUCTION

Before using the unit, be sure to read all operating instructions carefully. Please note that these are general precautions and may not pertain to your unit.

For example, this unit may not have the capability to be connected to an outdoor antenna.

1) Read these instructions.

All the safety and operating instructions should be read before the product is operated.

2) Keep these instructions.

The safety and operating instructions should be retained for future reference.

3) Heed all warnings.

All warnings on the product and in the operating instructions should be adhered to.

4) Follow all instructions.

All operating and use instructions should be followed.

5) Do not use this apparatus near water.

Do not use this product near water and moisture, for example: near a bathtub, washbowl, kitchen sink or laundry tub; in a wet basement; or near a swimming pool.

6) Clean only with dry cloth.

Unplug this product from the wall outlet before cleaning. Do not use liquid cleaners or aerosol cleaners. Use a dry cloth for cleaning.

7) Do not block any ventilation openings. Install in accordance with the manufacturer's instructions.

Slots and openings in the cabinet and in the back or bottom are provided for ventilation, to ensure reliable operation of the product and to protect it from overheating. These openings must not be blocked or covered. The openings should never be blocked by placing the product on a bed, sofa, rug or other similar surface. This product should never be placed near or over a radiator or heat source. This product should not be placed in a built-in installation such as a bookcase or rack unless proper ventilation is provided or the manufacturer's instructions have been adhered to.

8) Do not install near any heat sources such as radiators, heat registers, stoves, or other apparatus (including amplifiers) that produce heat.

9) Do not defeat the safety purpose of the polarized or grounding-type plug. A polarized plug has two blades with one wider than the other. A grounding type plug has two blades and a third grounding prong. The wide blade or the third prong are provided for your safety. If the provided plug does not fit into your outlet, consult an electrician for replacement of the obsolete outlet.

10) Protect the power cord from being walked on or pinched particularly at plugs, convenience receptacles, and the point where they exit from the apparatus.

11) Only use attachments/accessories specified by the manufacturer.

12) Use only with the cart, stand, tripod, bracket, or table specified by the manufacturer, or sold with the apparatus. When a cart is used, use caution when moving the cart/apparatus combination to avoid injury from tip-over.

An appliance and cart combination should be moved with care.

Quick stop, excessive force and uneven surfaces may cause the appliance and cart combination to overturn.



Portable Cart Warning

13) Unplug this apparatus during lightning storms or when unused for long periods of time.

To protect your product from a lightning storm, or when it is left unattended and unused for long periods of time, unplug it from the wall outlet and disconnect the antenna or cable system. This will prevent damage to the product due to lightning and power-line surges.

14) Refer all servicing to qualified service personnel. Servicing is required when the apparatus has been damaged in any way, such as power-supply cord or plug is damaged, liquid has been spilled or objects have fallen into the apparatus, the apparatus has been exposed to rain or moisture does not operate normally, or has been dropped.

15) Power source

This product should be operated only from the type of power source indicated on the marking label. If you are not sure of the type of power supply to your home, consult your appliance dealer or local power company. For products intended to operate from battery power, or other source, refer to the operation instructions.

16) Power lines

An outside antenna system should not be located in the vicinity of overhead power lines or other electric light or power circuits, or where it can fall into such power lines or circuits. When installing an outside antenna system, extreme care should be taken to keep from touching such power lines or circuits as contact with them might be fatal.

IMPORTANT SAFETY INSTRUCTION

17) Overloading

Do not overload wall outlets and extension cords as this can result in a risk of fire or electric shock.

18) Object and liquid entry

Never push objects of any kind into the product through openings as they may touch dangerous voltage points or short out parts that could result in fire or electric shock. Never spill or spray any type of liquid on the product.

19) Outdoor antenna grounding

If an outside antenna is connected to the product, be sure the antenna system is grounded so as to provide some protection against voltage surges and built up static charges. Section 810 of the National Electric Code ANSI/NFPA 70 provides information with respect to grounding of the mast and supporting structure, grounding of the lead-in wire to an antenna discharge product, size of grounding conductors, location of antenna-discharge product, connection to grounding electrodes and requirements for the grounding electrodes.

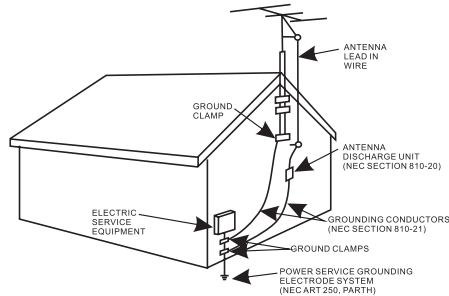

20) Service

Do not attempt to service this product yourself as opening or removing covers may expose you to dangerous voltage or other hazards. Refer all servicing to qualified service personnel.

21) Replacement parts

When replacement parts are required, be sure the service technician uses replacement parts specified by the manufacturer or those that have the same characteristics as the original parts. Unauthorized substitutions may result in fire or electric shock or other hazards.

22) Safety check

Upon completion of any service or repairs to this product, ask the service technician to perform safety checks to determine that the product is in proper operational condition.

23) Wall or ceiling mounting

The product should be mounted to a wall or ceiling only as recommended by the manufacturer.

24) Damage requiring service

Unplug this product from the wall outlet and refer service to qualified service personnel under the following conditions.

- When the power-supply cord or plug is damaged.
- If liquid has been spilled or objects have fallen into the product.
- If the product has been exposed to rain or water.
- If the product does not operate normally by following the operating instructions. Adjust only those controls that are covered by the operating instructions, as an adjustment of other controls may result in damage and will require extensive work by a qualified technician to restore the product to its normal operation.
- If the product has been dropped or the cabinet has been damaged.
- If the product exhibits a distinct change in performance—this indicates a need for service.

25) Note to CATV system installer

This reminder is provided to call the CATV system installer's attention to Article 820-40 of the NEC that provides guidelines for proper grounding and, in particular, specifies that the cable ground shall be connected to the grounding system of the building, as close to the point of cable entry as practical.

NOTE: Refer all servicing to qualified service personnel. Servicing is required when the unit has been damaged in any way such as the following: the power-supply cord or plug has been damaged, liquid has been spilled into unit, the unit has been exposed to rain or moisture, the unit has been dropped or the unit does not operate normally.

IMPORTANT SAFETY INSTRUCTION

NOTES ON HANDLING:

- When shipping the unit, always use the original shipping carton and packing materials. For maximum protection, repack the unit as it was originally packed at the factory.
- Do not use volatile liquids, such as insect spray, near the unit. Do not leave rubber or plastic products in contact with the unit for a long time. They will leave marks on the finish.
- The top and rear panels of the unit may become warm after a long period of use. This is normal and not a malfunction.
- When the DVD player is not in use, be sure to remove the disc and turn off the power.

NOTES ON LOCATING THE DVD PLAYER:

- When you place this unit near a TV, radio or VCR, the playback picture may become poor and the sound may be distorted. In this case, move the unit away from the TV, radio or VCR.

NOTES ON CLEANING:

Use a soft, dry cloth for cleaning

- For stubborn dirt, soak the cloth in a weak detergent solution, wring well and wipe. Use a dry cloth to wipe it dry. Do not use any type of solvent, such as thinner and benzene, as they may damage the surface of the unit.
- If you use a chemical-saturated cloth to clean the unit, follow that product's instructions.

Warning: Cleaning and adjustment of lenses and /or other components of playback mechanism should be performed by a qualified service technician.

NOTES ON MOISTURE CONDENSATION:

Moisture condensation damages the DVD player Please read the following carefully.

- Moisture condensation occurs, for example, when you pour a cold drink into a glass on a warm day. Drops of water form on the outside of the glass. In the same way, moisture may condense on the optical pick-up lens inside this unit, one of the most crucial internal parts of the DVD player.

Moisture condensation occurs during the following cases:

- When you bring the DVD player directly from a cold place to a warm place.
- When you use the DVD player in a room where you just turned on the heater, or a place where the cold wind from the air conditioner directly hits the unit.
- In summer, when you use the DVD player in a hot and humid place just after you moved the unit from an air conditioned room.
- When you use the DVD player in a humid place.

Do not use the DVD player when moisture condensation may occur.

- If you use the DVD player in such a situation, it may damage discs and internal parts. Remove the disc, connect the AC Cord to wall outlet, turn on the DVD player and leave it ON for two or three hours. After two or three hours, the DVD player will have warmed up and evaporated any moisture.

ABOUT DISCS

The region number for this DVD Player is:
See the following page for information regarding region numbers.



PLAYABLE DISCS:

The following discs can be played back on this DVD player:



DISC TYPES:

DVD

Data on most DVDs is divided into sections called titles and then into subsections called chapters, each of which is given a title or chapter number. Some features of this DVD player will not operate with some DVD discs as they are preset. If a function you selected does not run as desired, refer to the manual accompanying the DVD disc.

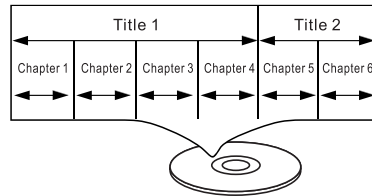

AUDIO CD

Data on an audio CD is divided into sections called tracks, each of which is given a track number.

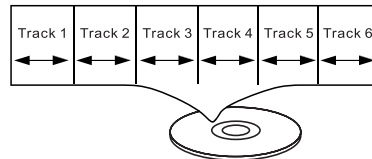

IMPORTANT:

It is important that you read the manual that accompanies the DVD disc, as there are features that are on the DVD player that cannot be used with certain DVDs. There are also extra features on the DVD disc that are different for each DVD disc, so they are not explained in this owner's manual.

This player conforms to the NTSC and PAL color systems. However, if you are in the USA, Canada or Mexico, leave this setting on NTSC. If incorrectly set to PAL, the TV picture may roll vertically. In this case, set the TV system to NTSC.

Notes on Copyright:

It is forbidden by law to copy, broadcast, show, broadcast on cable, play in public and rent copyrighted material without permission. DVD video discs are copy protected, and any recordings made from these discs will be distorted. This product incorporates copyright protection technology that is protected by method claims of certain U.S. Patents and other intellectual property rights owned by Macrovision Corporation, and is intended for home and other limited viewing uses only, unless otherwise authorized by Macrovision Corporation. Reverse engineering or disassembly is prohibited.

Region Management Information:

This DVD Player is designed and manufactured to respond to the Region Management Information that is recorded on a DVD disc. If the Region number described on the DVD disc does not correspond to the Region number of this DVD player, this DVD player cannot play that disc. You may not be able to play back some DVD video discs on this player if they were purchased from outside your geographic area or made for business purposes. When you try to play back an unauthorized disc, wrong Region appears on the TV screen.

LOCATION OF CONTROLS

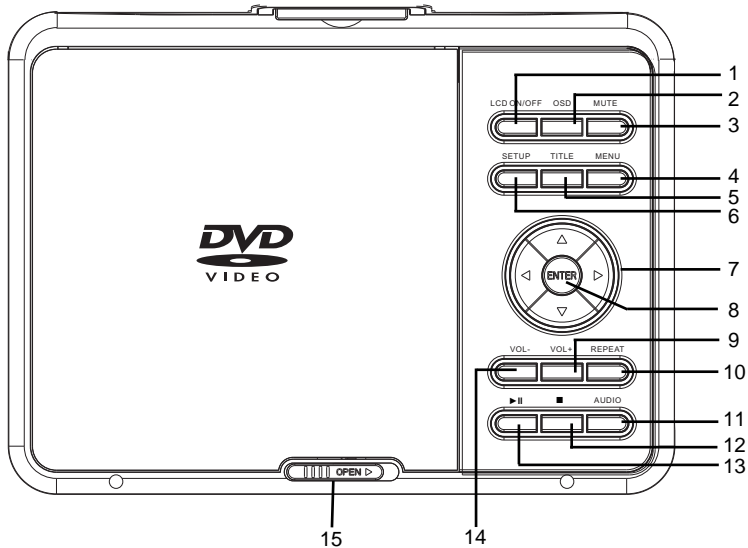

1. **LCD ON/OFF:** Press to turn on or turn off (Saving the battery power while music playback) the screen.
2. **OSD (On Screen Display):** Press to display the information.
3. **MUTE:** Press to turn off sound. Press again to resume.
4. **MENU:** Press to return to disc's menu page. (Function depends on the disc recording).
5. **TITLE:** Press to return to disc's title page. (Function depends on the disc recording).
6. **SETUP:** Press to enter DVD system setup menu and press again to exit.
7. **▲ ▼ ◀ ▶** Direction Buttons: Press to select the desired settings within setting menu.
8. **ENTER :** Press to confirm the selection (settings).
9. **VOL+ :** Press to increase the volume level.
10. **REPEAT:** Press repeatedly to select and set the repeat modes.
11. **AUDIO:** Press repeatedly to select the audio channels. (Function depends on the disc recording).
12. **■** Press to stop.
13. **▶||** Press to start playback or pause.
14. **VOL-:** Press to decrease volume level.
15. **OPEN:** Slide to right to open the disc door.

LOCATION OF CONTROLS

Right Side of the Player

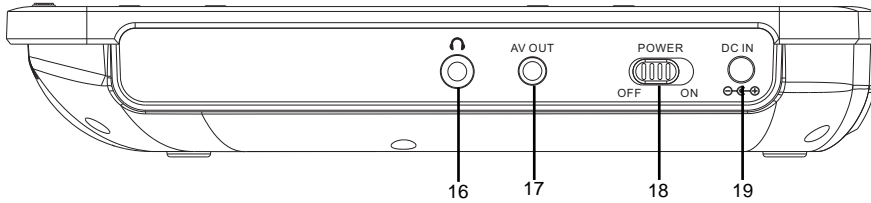

16. 📞 Phone Jack

17. AV(Audio/Video) output Jack

18. Power ON/OFF Switch

19. DC IN Jack

Front Side of the Player

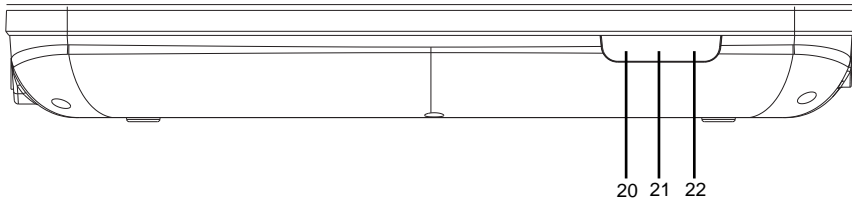

20. Charging Indicator

21. Remote Sensor

22. Power Indicator

LOCATION OF CONTROLS

REMOTE CONTROL

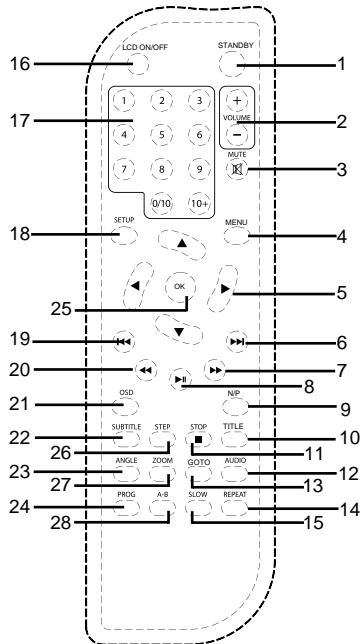

1. STANDBY Button
2. VOLUME +/- Buttons
3. MUTE Button
4. MENU Button
5. ◀ ▶ ▲ ▼ (Dirction) Buttons
6. ▶▶ (Next) Button
7. ▶▶▶ (Fast Forward) Button
8. ▶|| (Play/Pause) Button
9. N/P (NTSC/PAL) Button
10. TITLE Button
11. ■ STOP Button
12. AUDIO Button
13. GOTO Button
14. REPEAT Button
15. SLOW Button
16. LCD ON/OFF Button
17. Numeric 0-9 & 10+ Buttons
18. SETUP Button
19. ◀◀ (Previous) Button
20. ◀◀ (Fast Rewind) Button
21. OSD (On Screen Display) Button
22. SUBTITLE Button
23. ANGLE Button
24. PROG (Program) Button
25. OK Button
26. STEP Button
27. ZOOM Button
28. A-B Repeat Button

BATTERY INSTALLATION (REMOTE CONTROL)

Battery installation:

Install or replace the batteries as follows:

1. Press the tabs on the battery door and lift it off.
2. Install two (2) x AAA size batteries (included) into the battery compartment as the figure on the right and the polarity markings inside battery compartment.

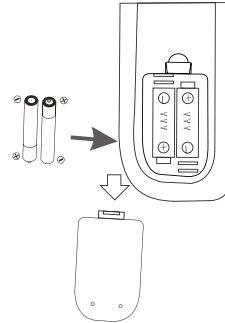

3. Replace the battery door.

Battery Precautions:

Follow these precautions when using a battery in this device:

1. Use only the size and type of battery specified.
2. Be sure to follow the correct polarity when installing the battery as indicated in the battery compartment. A reversed battery may cause damage to the device.
3. Do not mix different types of batteries together (eg. Alkaline and Carbon-zinc) or old batteries with fresh ones.
4. If the batteries in the device are consumed or the device is not to be used for a long period of time, remove the batteries to prevent damage or injury from possible battery leakage.
5. Do not try to recharge the battery not intended to be recharged; it can overheat and rupture. (Follow battery manufacturer's directions.)
6. Do not dispose of battery in fire. Battery may explode or leak.
7. Clean the battery contacts and also those of the device prior to battery installation.

Remote Control Sensor

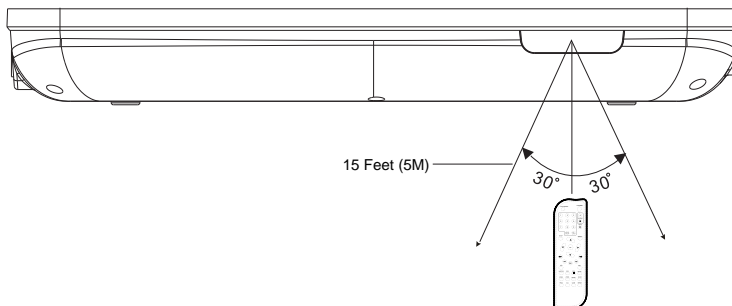

1. When there is an obstacle between the unit and the transmitter, the transmitter may not operation.
2. When direct sunlight, an incandescent lamp, fluorescent lamp or any other strong light shines on the remote control of the unit, the remote operation may be unstable.

POWER SOURCE

The unit has a built in Lithium-ion rechargeable battery. Recharge before use or when the battery is drained as follows:

Charging by the supplied AC/DC Adaptor:

1. Connect the small plug from the supplied AC/DC Adaptor to the DC IN Jack on the right of unit.
2. Connect the AC/DC Adaptor to the wall outlet having AC 100-240V~; 50/60Hz.
3. During charging, the RED Charging Indicator will illuminate.
When finished charging, it will turns to Green.

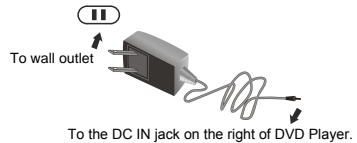

IMPORTANT: The AC/DC Adaptor is intended to be correctly orientated in a vertical or floor mount position.

Notes: Your battery will last longer if you follow these simple guidelines for caring and storing it.

- A: Before first time use, recharge the unit approximate 2.5 hours until the unit is fully charged.
- B: Recharge and store the device within the temperature range of 5°C~35°C (40°F~95°F).
- C: Do not overcharge (longer than 24 hours). Excessive charging or discharging may shorten the battery's life.
- D: Battery life naturally shortens slowly over time.
- E: The rechargeable battery incorporated in this product is not replaceable.

Charging by the supplied Car Adaptor:

Connect the unit to the cigarette lighter socket of a vehicle that has a 12V battery as the illustrated below. During charging, the RED Charging Indicator will illuminate. When finished charging, it will turns to Green.

IMPORTANT:

- A: **This unit is NOT compatible with a vehicle that has a 24V battery.**
- B: This is a special negative grounded Car Adapter. Using this Car Adapter with a plus grounded car can cause malfunction.
- C: Do NOT plug in the Car Adapter until the car ignition is turned on.
- D: Disconnect the Car Adapter from the cigarette lighter socket and the unit after use.

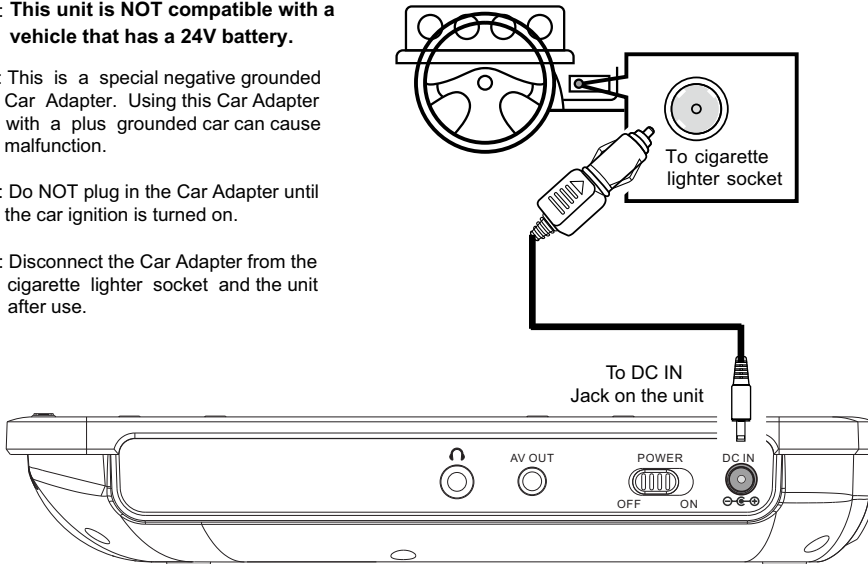

CONNECTIONS

1. Connecting to a TV with AV connection cable

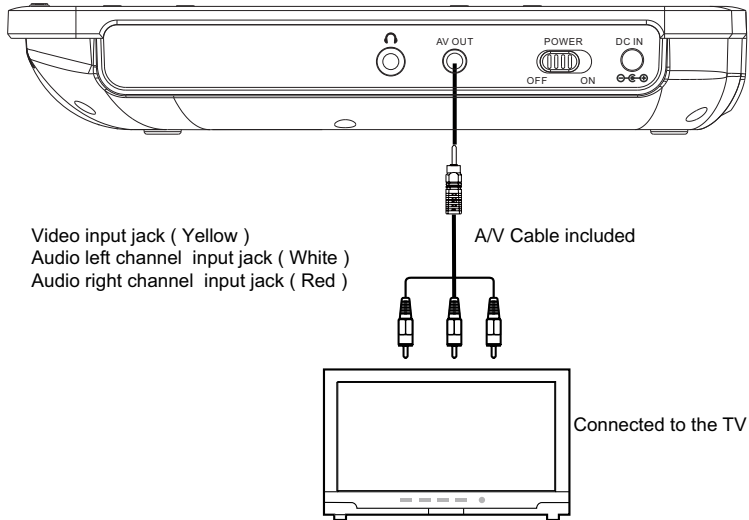

EARPHONE:

For private listening, connect the supplied Earbuds into the  (Earphone) Jack on the right of unit. The speakers will be auto cut off when the Earbuds are inserted into the jack.

SWIVEL PANEL

The viewing angle of the swivel panel can be adjusted as below as desired:

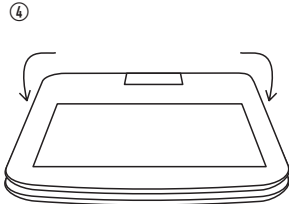
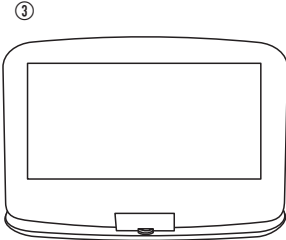
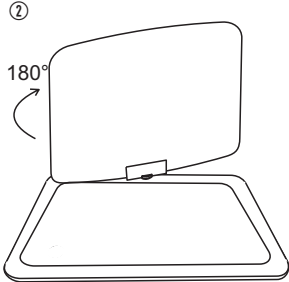
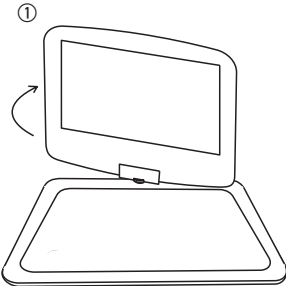

OPERATIONS

Playback of a DVD:

1. Lift up the panel and turn to desired angle. Slide the Power ON/OFF Switch to "ON" position to power on the unit, the Green Power On Indicator on front of the player will illuminate.
2. Slide the OPEN Switch to right to open the disc door. Place the disc on the center spindle with label side facing up. Close the disc door and the player will start playback automatically.
3. During playback:
 - ~ Press the ►► or ◀◀ Buttons repeatedly to fast search for a specific section forward/backward.
Press the ►|| Button to resume normal playback.
 - ~ Press the ►► or ◀◀ Buttons repeatedly to skip to specific track.
 - ~ Press the ►|| Button to pause, press the ►|| Button again to resume normal playback.
 - ~ Press the VOL (Volume) +/- Buttons to adjust volume level.
 - ~ Press the STOP ■ Button to stop playback. The player will remember the point where the disc was stopped. When press the ►|| Button again, playback will start from this point. To stop playback completely or to start from the beginning, press the STOP ■ Button twice.
4. To power off, press the STANDBY Button on the Remote Control to turn the player to standby mode. The color of Power Indicator will turns to Red. Press the STANDBY Button again to turns the player on from standby mode. (For saving energy, always power off the player by slide the Power ON/OFF Switch on the player to OFF position or unplug the AC/DC Adaptor from player and wall outlet.)

Repeat Playback:

- During playback, press the REPEAT Button once; " ↺ Chapter " will appear on the screen then the current Chapter will be playback repeatedly and continuously.
- Press the REPEAT Button twice; " ↺ Title " will appear on the screen then the current Title will be playback repeatedly and continuously.
- Press the REPEAT Button three times; " ↺ ALL " will appear on the screen then all files on the current DVD disc will be playback repeatedly and continuously.
- Press the REPEAT Button repeatedly until all the repeat indicators disappear on the screen to turn off the the repeat mode.

Playback of a CD:

1. Lift up the panel and turn to desired angle. Slide the Power ON/OFF Switch to "ON" position to power on the unit, the Green Power On Indicator on front of the player will illuminate.
2. Slide the OPEN Switch to right to open the disc door. Place the disc on the center spindle with label side facing up. Close the disc door and the player will start playback automatically.
3. During playback:
 - ~ Press the ►► or ◀◀ Buttons repeatedly to fast search for a specific section forward/backward.
Press the ►|| Button to resume normal playback.
 - ~ Press the ►► or ◀◀ Buttons repeatedly to skip to specific track.
 - ~ Press the ►|| Button to pause, press the ►|| Button again to resume normal playback.
 - ~ Press the VOL (Volume) +/- Buttons to adjust volume level.
 - ~ Press the STOP ■ Button to stop playback. The player will remember the point where the disc was stopped. When press the ►|| Button again, playback will start from this point. To stop playback completely or to start from the beginning, press the STOP ■ Button twice.
4. To power off, press the STANDBY Button on the Remote Control to turn the player to standby mode. The color of Power Indicator will turns to Red. Press the STANDBY Button again to turns the player on from standby mode. (For saving energy, always power off the player by slide the Power ON/OFF Switch on the player to OFF position or unplug the AC/DC Adaptor from player and wall outlet.)

Repeat Playback:

- During playback, press the REPEAT Button once; " ↺ Track " will appear on the screen then the current playing track will be playback repeatedly and continuously.
- Press the REPEAT Button twice; " ↺ ALL " will appear on the screen then all the tracks on the current disc will be playback repeatedly and continuously.
- Press the REPEAT Button repeatedly until all repeat indicators disappear on the screen to turn off repeat mode.

CD or DVD programming:

1. During CD or DVD playback, press the **PROG** (Program) Button. The Program menu will appear as follows.

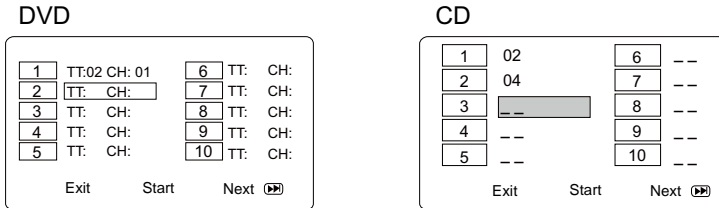

2. Using the Direction and Numeric Buttons to select and set the desired TT (Title), CH (Chapters), tracks (for CD) of the movie (music) you wants.
3. Using the Direction Buttons to select and highlight the "Start" Button on the screen then press the ENTER/OK Buttons to start program playback.

Playback of a JPEG (PICTURE); MP3 disc:

1. Power on the player and place the disc into the player as previous procedures.
The folder/files list will appear on the screen.
2. Use the Direction Buttons to select and highlight the desired folder then press the ENTER Button on the unit or OK Button on the Remote Control to enter. The file list will appear on the screen.
3. Using the Direction Buttons to select and highlight the desired file then press the ENTER/OK or Play/Pause **▶||** Buttons to start playback.

Repeat:

During playback, press the REPEAT Button repeatedly to select:

- ~ Random: Playback the track randomly.
- ~ Single: Playback the current track only, when finish, it will stop playback.
- ~ Repeat One: Playback the current track repeatedly.
- ~ Repeat Folder: Playback the tracks in the current folder repeatedly.
- ~ Folder: Normal playback.

Notes:

1. Disc loading period of the JPEG/MP3 discs may be longer than loading DVD disc.
2. Other operation is similar to CD disc playing.

IMPORTANT NOTES:

- Some discs may take a few seconds to load. If a disc is inserted incorrectly, dirty, damaged, or is not present at all, "No Disc" or "Bad Disc" will appear in the display.
- Always hold the disc without touching either of its surfaces. When inserting a disc, position it with the printed title side facing up, align it with the guides and place it in its proper position.
- It is important that you read the manual that accompanies the DVD disc as there are features that are on this DVD player that cannot be used with certain DVDs. There are also extra features that are different for each DVD disc, so they are not explained in this owner's manual.

CONTROLS:

LCD ON/OFF

Press to turn on or off (saving the battery power in music playback mode) the LCD display.

STANDBY

Press to turn to standby mode. Press again to turn on.

VOL (Volume) +/-

Press to increase or decrease volume.

MUTE

Press to turn off the sound, press again to resume.

MENU

Press to return to disc's menu page (Function depends on the recording of the disc).

OSD (On Screen Display)

During playback, press the OSD button repeatedly to read the information of playback status.

N/P (PAL/NTSC)

Press to switch to NTSC or PAL TV system.

SUBTITLE

During DVD playback, press repeatedly to select the desired subtitle (Function depends on the recording of disc).

ZOOM

During movies playback, press the ZOOM Button repeatedly to zoom in (or out) the picture. In zoom in mode, press the Direction Buttons to select the parts of the zoomed picture to watch. This function is not available on all disc.

AUDIO

During DVD playback, press repeatedly to select the desired language or sound channel (Function depends on the recording of disc).

A-B Repeat

During playback, press the A-B Button to define where is the start point of the section you wants to repeat to play. Press the A-B Button again to define the end point of the section. The unit will auto starts to play the selected section repeatedly and continuously. Press the A-B Button again to resume normal playback. (This function is not available on all discs).

SLOW

During playback, press the SLOW Button repeatedly to set the slow motion speed. Press the ►|| Button to resume normal playback.

STEP

During movie playback, press the STEP Button repeatedly to play the movie frame by frame. Press the ►|| Button to resume to normal playback.

TITLE

Press to return to disc's title page (Function depends on the recording of the disc).

ANGLE

During DVD playback, press repeatedly to select the viewing angle (Function depends on the recording of disc).

STEP

During movie playback, press the STEP Button repeatedly to play the movie frame by frame.
Press the ►|| Button to resume to normal playback.

TITLE

Press to return to disc's title page (Function depends on the recording of the disc).

ANGLE

During DVD playback, press repeatedly to select the viewing angle (Function depends on the recording of disc).

GOTO

DVD:

- ~ To select the desired Title and Chapter, press the GOTO Button once, the Title and Chapter selection menu will appear on the screen. Use the Direction and Numeric Buttons to select the desired title and chapter, the player will auto start to plays the selected Chapter/Title.
- ~ Select the desired establish time by Title to play, press the GOTO Button twice, the time selection table will appear on the screen. Using the Direction and Numeric Buttons to enter the desired establish time. The player will auto start to play the current title from the selected establish time.
- ~ Select the desired establish time by Chapter to play, press the GOTO Button three times, the time selection table will appear on the screen. Using the Direction and Numeric Buttons to enter the desired established time. The player will auto start to play the current chapter from the selected establish time.

CD:

- ~ Press GOTO Button once, the "Disc Go To: --:--" will appear on the display. Using the Direction and Numeric Buttons to enter the desired establish time of current disc. The player will auto start to play the current disc from the selected establish time.
- ~ Press GOTO Button twice, the "Track Go To: --:--" will appear on the display. Using the Direction and Numeric Buttons to enter the desired establish time of current tract. The player will auto start to play the current track from the selected establish time.
- ~ Press GOTO Button three times, the "Select Track: --:--" will appear on the display. Using the Numeric Buttons to enter the number of the desired track. The player will auto start to play it.

SYSTEM SETUP

Setting Menus:

In no disc mode, press the SETUP Button, the setting menu will appear on the screen as below.

Using the Direction ◀, ▶, ▲, ▼ Buttons to select and highlight the function you need to set or reset. Press the ENTER Button on the unit or OK Button on the Remote Control to enter or confirm the selection. After setting, press the SETUP Button to save the settings and exit.

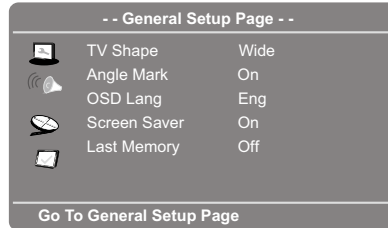

In General Setup Page:

1. If TV Shape is selected, using the Direction and ENTER/OK Buttons to set the aspect ratio to match the aspect ratio of the playing movie and connected external television.
2. If Angle Mark is selected, using the Direction and ENTER/OK Buttons to set it On or Off. If set to On, when multi-angles are available in the playing DVD, the multi-angle logo 𠄎 will appear on the screen.
3. If OSD Lang (On Screen Display Language) is selected, using the Direction and ENTER/OK Buttons to set the OSD language as desired.
4. If Screen Saver is selected, using the Direction and ENTER/OK Buttons to set it On or Off. If set to On, the screen saver will come on when the unit idle or the image is paused over approximately five minutes.
5. If Last Memory is selected, using the Direction and ENTER/OK Buttons to set it On or Off. If set to On, the unit will start playback from the point where the disc was stopped last time.

In Speaker Setup Page:

If Downmix is selected, using the Direction and ENTER/OK Buttons to set it to Lt/Rt; Stereo as desired.

~ If set to Lt/Rt, the rear left and rear right channels will play on both Left and Right Speakers.

~ If set to Stereo, the rear left channel will play on Left Speaker; the rear right channel will play on Right Speaker.

SYSTEM SETUP

In Video Quality Setup Page:

1. If Picture is selected, using the Direction and ENTER/OK Buttons to set the panel quality such like Sharpness; Brightness; Contrast; Hue or Saturation as desired.
2. If Picture Quality is selected, using the Direction and ENTER/OK Buttons to set the picture quality when the DVD Player connected through AV OUT signal.
3. If Panel Display is selected, using the Direction and ENTER/OK Buttons to set the aspect ratio of the screen to Wide 16:9 or 4:3 to match the aspect ration of playing video or photos.

In Preference Page:

1. If TV Type is selected, using the Direction and ENTER/OK Buttons to set to PAL, AUTO or NTSC.
(Note: The TV system in US, Canada and Mexico is NTSC).
2. If Audio, Subtitle or Disc Menu is selected, using the Direction and ENTER/OK Buttons to set the priority of the available language. (Function depend the recording of DVD).
3. If Parental is selected, using the Direction and ENTER/OK Buttons to set the rating level as desired as follows:
 - ~ Press the ► Button to enter, the current rating level will be highlighted.
 - ~ Press the ▲ or ▼ Buttons to select the new level as desired.
 - ~ Press the ENTER/OK Butons to enter, password enter window will pop up.
 - ~ Enter the six digit password (default password is 136900) by pressing the Numeric Buttons.
 - ~ Press the ENTER/OK Butons to save the settings and exit.
 - ~ Rate levels:

1. Kid Saf:	Kid safe
2. G:	All ages
3. Pg:	Parental Guidance
4. Pg13:	Parental Guidance less than 13 years old
5. Pgr:	Under 17 years old, Parental Guidance suggested
6. R:	Under 17 years old, Parental Guidance strongly
7. Nc17:	17 years old or above
8. Adult:	Adult only
4. If Password is selected, press the ENTER/OK Buttons to enter, the subsetting menu will appear:
 - ~ If Password Mode is selected, using the Direction and ENTER/OK Buttons to set it On (activate the rating level setting) or Off (Password is needed).
 - ~ If Password is selected, press the ENTER/OK Buttons twice to enter. The New password setting menu will appear.
 - > Enter the six digit old password. The Column of NEW Password will be highlighted.
 - > Enter the new six digit password. The Column of Confirm Pwd will be highlighted.
 - > Enter the new password again. The OK Button on the screen will be highlighted.
 - > Press the ENTER/OK Buttons to save the setting and exit.
5. If Default is selected, using the Direction and ENTER/OK Buttons to reset all setting to default setting or press the SETUP Button to exit without changes.

CARE AND MAINTENANCE

Caring for Discs

- Treat the disc carefully. Handle the disc only by its edges. Never allow your fingers to contact with the shiny, unprinted side of the disc.

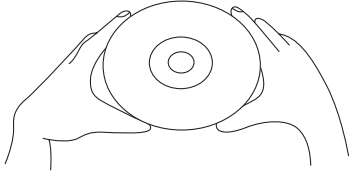

- Do not attach adhesive tape, stickers, etc. to the disc label.
- Clean the disc periodically with a soft, lint-free, dry cloth. Never use detergents or abrasive cleaners to clean the disc. If necessary, use a CD cleaning kit.
- If a disc skips or gets stuck on a section of the disc, it is probably dirty or damaged (scratched).
- When cleaning the disc, wipe in straight lines from the center of the disc to the outer edge of the disc. Never wipe in circular motions.

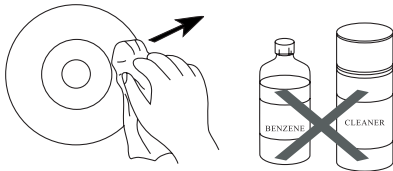

- Discs should be stored in their cases after each use to avoid damage.
- Do not expose discs to direct sunlight, high temperatures or dust, etc. Prolonged exposure or extreme temperatures can warp the disc.
- Do not stick or write anything on either side of the disc. Sharp writing Instruments, or the ink, may damage the surface.

Cleaning the Unit

- To prevent fire or shock hazard, disconnect your unit from the AC power source when cleaning.
- The finish on your unit may be cleaned with a dust cloth and cared for as other furniture. Use caution when cleaning and wiping the plastic parts.
- Mild soap and a damp cloth may be used on the front panel.

SPECIFICATIONS

Power Source: Built-in DC=7.4V, 1200mAh (8.88WH) Lithium-ion rechargeable battery, recharge by DC=9-12V, 1A through the DC IN Jack

Power Source of Remote Control: DC=3V, 2 x AAA Size Batteries (included)

Disc Compatibility: DVD/CD/CD-R/CD-RW/
DVD± R/DVD± RW/MP3/JPEG

ACCESSORIES

1 x User's Manual

1 x AC/DC Adaptor (Input: AC 100-240V~, 50/60Hz, 0.5A Max; Output: DC= 9V, 1000mA ⓈⓈ)

1 x Remote Control

2 x AAA Size Batteries (For Remote Control)

1 x Car Adaptor (Input: DC = 12V, 2A; Output: DC= 12V, 2A; Type of Built-in Fuse: F2AL250V)

1 x Stereo Earbuds

1 x Audio/Video Connection Cable

**SPECIFICATIONS AND ACCESSORIES ARE SUBJECT TO CHANGE
WITHOUT NOTICE**

LIMITED WARRANTY

Craig Electronics warrants this product to be free from manufacturing defects in material and workmanship under normal use for a period of 180 days from date of purchase. If service is required, please return the product to the store where it was purchased for exchange; or, pack the unit in the original packing material with all accessories if applicable, a copy of your sales receipt and a Cashier's check or Money Order for \$18 (to cover shipping and handling costs) payable to Craig Electronics Inc. For consumers in Canada, please make sure that the cashier check or money order is redeemable through a U.S. bank. Ship your product freight pre-paid. Your unit will be repaired, replaced or if the unit can not be repaired or replaced, a refund will be forwarded to you within four weeks of receipt of your unit. Please ship your unit to:

Craig Electronics Inc.
1160 NW 163 Drive
Miami, FL 33169

This warranty is void if the product has been: a) Used in a commercial application or rental. b) Damaged through misuse, negligence, or abuse. c) Modified or repaired by anyone other than an authorized Craig service center. d) Damaged because it is improperly connected to any other equipment.

Note: This warranty does not cover: a) Ordinary adjustments as outlined in the Owner's Manual which can be performed by the customer. b) Damage to equipment not properly connected to the product. c) Any cost incurred in shipping the product for repair. d) Damage to the product not used in the USA.

This warranty is not transferable and only applies to the original purchase. Any implied warranties, including the warranty of merchantability, are limited in duration to the period of this expressed warranty and no warranty whether expressed or implied shall apply to the product thereafter.

Under no circumstance shall Craig be liable for any loss or consequential damage arising out of the use of this product. This warranty gives specific legal rights. However, you may have other rights which may vary from state to state. Some states do not allow limitations on implied warranties or exclusion of consequential damage. Therefore, these restrictions may not apply to you.

This product has been manufactured by and is sold under the responsibility of Craig Electronics Inc, and Craig Electronics Inc is the warrantor in relation to this product. MAGNAVOX and SMART. VERY SMART are registered trademarks of Koninklijke Philips N.V. and are used under license from Koninklijke Philips N.V.

To Obtain Service on your Product
email: service@craigelectronics.com